



X11SCL-F

USER'S MANUAL

Revision 1.0c

The information in this User's Manual has been carefully reviewed and is believed to be accurate. The vendor assumes no responsibility for any inaccuracies that may be contained in this document, and makes no commitment to update or to keep current the information in this manual, or to notify any person or organization of the updates. **Please Note: For the most up-to-date version of this manual, please see our website at www.supermicro.com.**

Super Micro Computer, Inc. ("Supermicro") reserves the right to make changes to the product described in this manual at any time and without notice. This product, including software and documentation, is the property of Supermicro and/or its licensors, and is supplied only under a license. Any use or reproduction of this product is not allowed, except as expressly permitted by the terms of said license.

IN NO EVENT WILL Super Micro Computer, Inc. BE LIABLE FOR DIRECT, INDIRECT, SPECIAL, INCIDENTAL, SPECULATIVE OR CONSEQUENTIAL DAMAGES ARISING FROM THE USE OR INABILITY TO USE THIS PRODUCT OR DOCUMENTATION, EVEN IF ADVISED OF THE POSSIBILITY OF SUCH DAMAGES. IN PARTICULAR, SUPER MICRO COMPUTER, INC. SHALL NOT HAVE LIABILITY FOR ANY HARDWARE, SOFTWARE, OR DATA STORED OR USED WITH THE PRODUCT, INCLUDING THE COSTS OF REPAIRING, REPLACING, INTEGRATING, INSTALLING OR RECOVERING SUCH HARDWARE, SOFTWARE, OR DATA.

Any disputes arising between manufacturer and customer shall be governed by the laws of Santa Clara County in the State of California, USA. The State of California, County of Santa Clara shall be the exclusive venue for the resolution of any such disputes. Supermicro's total liability for all claims will not exceed the price paid for the hardware product.

FCC Statement: This equipment has been tested and found to comply with the limits for a Class A digital device pursuant to Part 15 of the FCC Rules. These limits are designed to provide reasonable protection against harmful interference when the equipment is operated in industrial environment. This equipment generates, uses, and can radiate radio frequency energy and, if not installed and used in accordance with the manufacturer's instruction manual, may cause harmful interference with radio communications. Operation of this equipment in a residential area is likely to cause harmful interference, in which case you will be required to correct the interference at your own expense.

California Best Management Practices Regulations for Perchlorate Materials: This Perchlorate warning applies only to products containing CR (Manganese Dioxide) Lithium coin cells. "Perchlorate Material-special handling may apply. See www.dtsc.ca.gov/hazardouswaste/perchlorate".



WARNING: This product can expose you to chemicals including lead, known to the State of California to cause cancer and birth defects or other reproductive harm. For more information, go to www.P65Warnings.ca.gov.

The products sold by Supermicro are not intended for and will not be used in life support systems, medical equipment, nuclear facilities or systems, aircraft, aircraft devices, aircraft/emergency communication devices or other critical systems whose failure to perform be reasonably expected to result in significant injury or loss of life or catastrophic property damage. Accordingly, Supermicro disclaims any and all liability, and should buyer use or sell such products for use in such ultra-hazardous applications, it does so entirely at its own risk. Furthermore, buyer agrees to fully indemnify, defend and hold Supermicro harmless for and against any and all claims, demands, actions, litigation, and proceedings of any kind arising out of or related to such ultra-hazardous use or sale.

Manual Revision 1.0c

Release Date: April 06, 2020

Unless you request and receive written permission from Super Micro Computer, Inc., you may not copy any part of this document. Information in this document is subject to change without notice. Other products and companies referred to herein are trademarks or registered trademarks of their respective companies or mark holders.

Copyright © 2020 by Super Micro Computer, Inc.
All rights reserved.

Printed in the United States of America

Preface

About This Manual

This manual is written for system integrators, IT technicians, and knowledgeable end users. It provides information for the installation and use of the X11SCL-F motherboard.

About This Motherboard

The Super X11SCL-F motherboard supports an Intel® Xeon® E-2200/2100, 9th/8th Generation Core i3, Pentium, and Celeron (Socket H4 - LGA 1151) series processor with up to six cores and a thermal design power (TDP) of up to 95W. Built with the Intel C242 chipset, this motherboard supports 4-DIMM DDR4 ECC unbuffered (UDIMM) memory (2-DIMM per channel) with speeds of up to 2666MHz. It features PCI-Express 3.0 slots, SATA 3.0 and dual 1GbE LAN ports, a Trusted Platform Module (TPM) header, and a M.2 connector with Intel Optane Memory support. The X11SCL-F is optimized for entry-level general purpose computing with three PCI-Express expansion slots, which is ideal for cloud storage. Please note that this motherboard is intended to be installed and serviced by professional technicians only. For processor/memory updates, please refer to our website at <http://www.supermicro.com/products/>.

Conventions Used in the Manual

Special attention should be given to the following symbols for proper installation and to prevent damage done to the components or injury to yourself:



Warning! Indicates important information given to prevent equipment/property damage or personal injury.



Warning! Indicates high voltage may be encountered while performing a procedure.



Important: Important information given to ensure proper system installation or to relay safety precautions.



Note: Additional Information given to differentiate various models or provides information for proper system setup.

Contacting Supermicro

Headquarters

Address: Super Micro Computer, Inc.
980 Rock Ave.
San Jose, CA 95131 U.S.A.

Tel: +1 (408) 503-8000

Fax: +1 (408) 503-8008

Email: marketing@supermicro.com (General Information)
support@supermicro.com (Technical Support)

Website: www.supermicro.com

Europe

Address: Super Micro Computer B.V.
Het Sterrenbeeld 28, 5215 ML
's-Hertogenbosch, The Netherlands

Tel: +31 (0) 73-6400390

Fax: +31 (0) 73-6416525

Email: sales@supermicro.nl (General Information)
support@supermicro.nl (Technical Support)
rma@supermicro.nl (Customer Support)

Website: www.supermicro.nl

Asia-Pacific

Address: Super Micro Computer, Inc.
3F, No. 150, Jian 1st Rd.
Zhonghe Dist., New Taipei City 235
Taiwan (R.O.C)

Tel: +886-(2) 8226-3990

Fax: +886-(2) 8226-3992

Email: support@supermicro.com.tw

Website: www.supermicro.com.tw

Table of Contents

Chapter 1 Introduction

1.1 Checklist	8
Quick Reference	11
Quick Reference Table	12
Motherboard Features	14
1.2 Processor and Chipset Overview	18
1.3 Special Features	18
Recovery from AC Power Loss	18
1.4 System Health Monitoring	18
Onboard Voltage Monitors	18
Fan Status Monitor with Firmware Control	19
Environmental Temperature Control	19
System Resource Alert	19
1.5 ACPI Features	19
1.6 Power Supply	20
1.7 Serial Port	20

Chapter 2 Installation

2.1 Static-Sensitive Devices	21
Precautions	21
Unpacking	21
2.2 Motherboard Installation	22
Tools Needed	22
Location of Mounting Holes	22
Installing the Motherboard	23
2.3 Processor and Heatsink Installation	24
Installing the LGA 1151 Processor	24
Installing an Active CPU Heatsink with Fan	26
Removing the Heatsink	28
2.4 Memory Support and Installation	29
Memory Support	29
General Guidelines for Optimizing Memory Performance	30
DIMM Installation	31

DIMM Removal	31
2.5 Rear I/O Ports	32
2.6 Front Control Panel	37
2.7 Connectors	42
Power Connections	42
Headers	44
2.8 Jumper Settings	51
How Jumpers Work.....	51
2.9 LED Indicators.....	54
Chapter 3 Troubleshooting	
3.1 Troubleshooting Procedures	57
Before Power On	57
No Power	57
No Video	58
System Boot Failure	58
Memory Errors	58
Losing the System's Setup Configuration.....	59
When the System Becomes Unstable	59
3.2 Technical Support Procedures	61
3.3 Frequently Asked Questions	62
3.4 Battery Removal and Installation	63
Battery Removal.....	63
Proper Battery Disposal.....	63
Battery Installation.....	63
3.5 Returning Merchandise for Service.....	64
Chapter 4 BIOS	
4.1 Introduction.....	65
4.2 Main Setup	66
4.3 Advanced Setup Configurations.....	68
4.4 Event Logs	91
4.5 IPMI	93
4.6 Security.....	96
4.7 Boot	100
4.8 Save & Exit.....	104

Appendix A BIOS Codes

A.1 BIOS Error POST (Beep) Codes	106
----------------------------------------	-----

Appendix B Software Installation

B.1 Installing Software Programs	108
----------------------------------------	-----

B.2 SuperDoctor® 5.....	109
-------------------------	-----

Appendix C Standardized Warning Statements**Appendix D UEFI BIOS Recovery**

D.1 Overview.....	113
-------------------	-----

D.2 Recovering the UEFI BIOS Image.....	113
-----------------------------------------	-----

D.3 Recovering the Main BIOS Block with a USB Device	114
------------------------------------------------------------	-----

Chapter 1

Introduction

Congratulations on purchasing your computer motherboard from an industry leader. Supermicro motherboards are designed to provide you with the highest standards in quality and performance.

In addition to the motherboard, several important parts that are included with your shipment are listed below. If anything listed is damaged or missing, please contact your retailer.

1.1 Checklist

Main Parts List		
Description	Part Number	Quantity
Supermicro Motherboard	X11SCL-F	1
I/O Shield	MCP-260-00042-0N	1
SATA Cables	CBL-0044L	6
Quick Reference Guide	MNL-2063-QRG	1

Important Links

For your system to work properly, please follow the links below to download all necessary drivers/utilities and the user's manual for your server.

- Supermicro product manuals: <http://www.supermicro.com/support/manuals/>
- Product drivers and utilities: <https://www.supermicro.com/wftp/driver/>
- Product safety info: http://www.supermicro.com/about/policies/safety_information.cfm
- A secure data deletion tool designed to fully erase all data from storage devices can be found at our website: https://www.supermicro.com/wftp/utility/Lot9_Secure_Data_Deletion_Utility/
- If you have any questions, please contact our support team: support@supermicro.com

This manual may be periodically updated without notice. Please check the Supermicro website for possible updates to the manual revision level.

Figure 1-1. X11SCL-F Motherboard Image

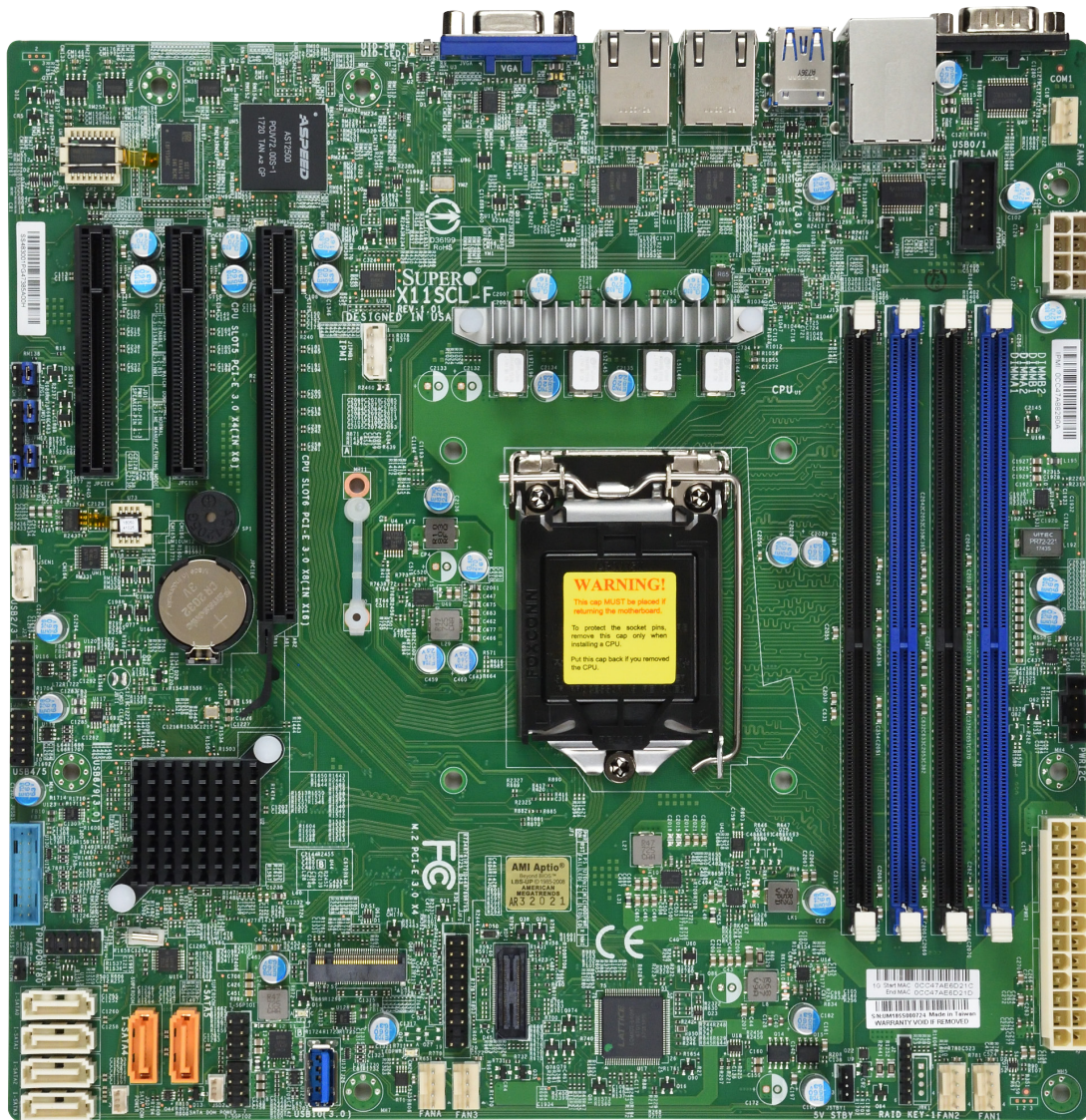

Note: All graphics shown in this manual were based upon the latest PCB revision available at the time of publication of the manual. The motherboard you received may or may not look exactly the same as the graphics shown in this manual.

Figure 1-2. X11SCL-F Motherboard Layout (not drawn to scale)

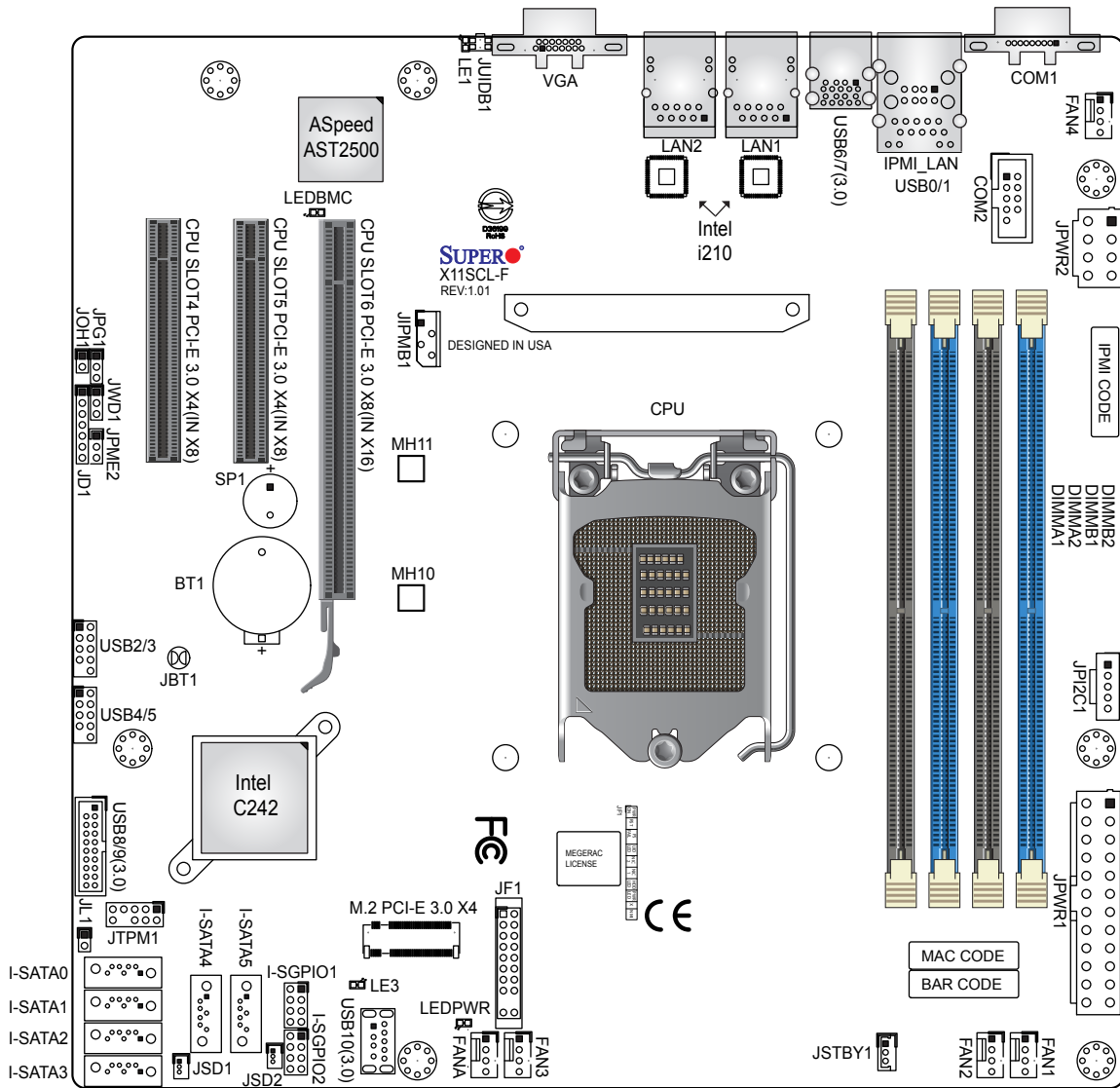

 **Note:** Components not documented are for internal testing only.

Quick Reference

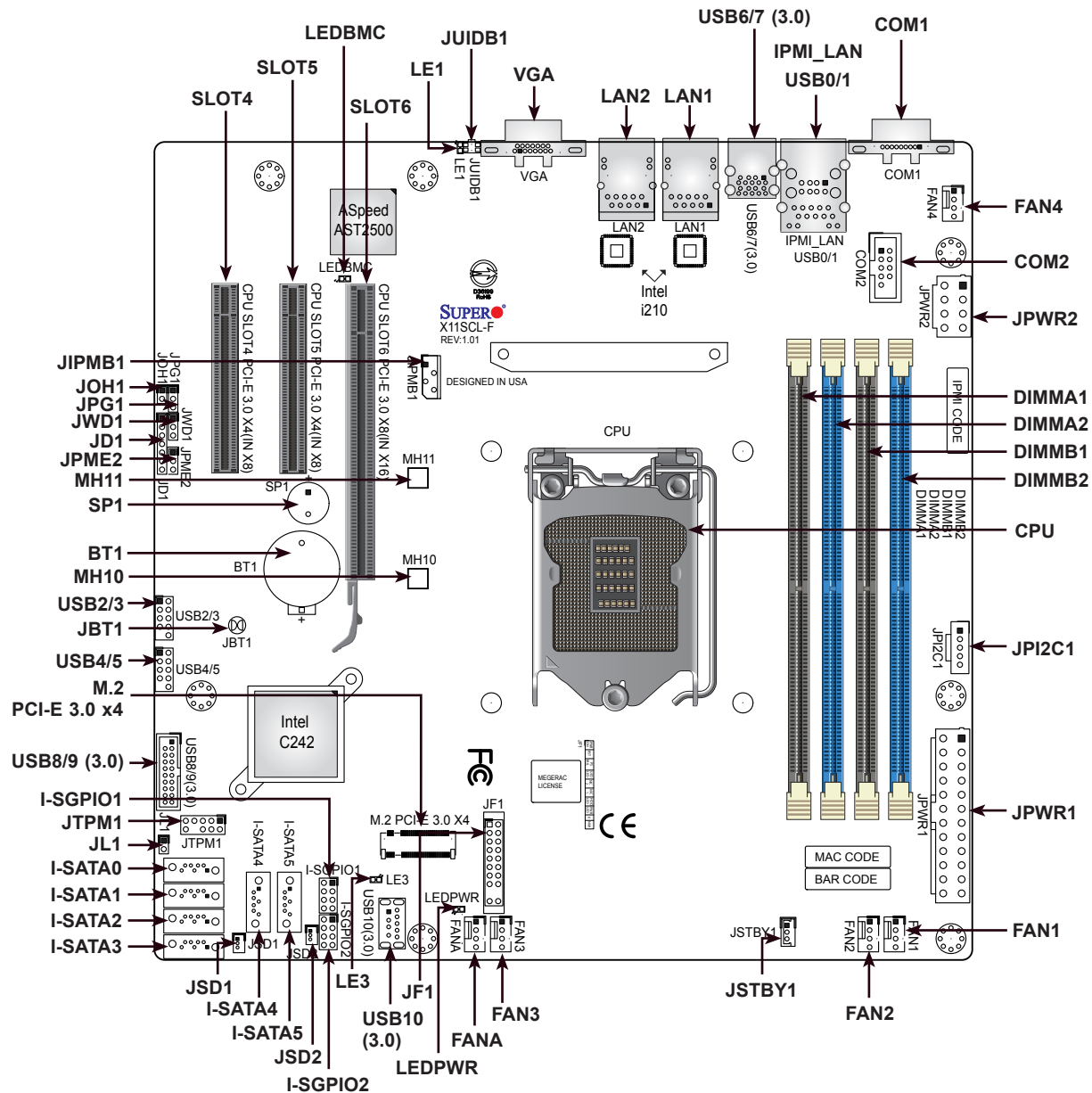

Notes:

- See Chapter 2 for detailed information on jumpers, I/O ports, and JF1 front panel connections.
- "■" indicates the location of Pin 1.
- Jumpers/components/LED indicators not indicated are used for internal testing only.
- Use only the correct type of onboard CMOS battery as specified by the manufacturer. Do not install the onboard battery upside down to avoid possible explosion.

Quick Reference Table

Jumper	Description	Default Setting
JBT1	CMOS Clear	Open (Normal)
JPG1	VGA Enable	Pins 1-2 (Enabled)
JPME2	ME Manufacturing Mode	Pins 1-2 (Normal)
JWD1	Watchdog Timer	Pins 1-2 (Reset)

LED	Description	Status
LE1	Unit Identifier (UID) LED	Solid Blue: Unit Identified
LE3	M.2 LED	Blinking Green: Device Working
LEDBMC	BMC Heartbeat LED	Blinking Green: BMC Normal
LEDPWR	Onboard Power LED	Solid Green: Power On



Connector	Description
BT1	Onboard Battery
COM1, COM2	COM Port, COM Header
FAN1 ~ FAN4	CPU/System Fan Headers
FANA	PCH Fan Header
IPMI_LAN	Dedicated IPMI LAN Port
I-SATA0 ~ I-SATA5	Intel® PCH SATA 3.0 Ports (with RAID 0, 1, 5, 10) I-SATA4 and I-SATA5 supports SuperDOM
I-SGPIO1, I-SGPIO2	Serial Link General Purpose I/O Headers
JD1	Power LED Indicator/Speaker Header (Pins 1-3: Power LED; Pins 4-7: Speaker)
JF1	Front Control Panel Header
JIPMB1	4-pin BMC External I ² C Header (for an IPMI card)
JL1	Chassis Intrusion Header
JOH1	Overheat/Fan Fail LED Header
JPI ² C1	Power I ² C System Management Bus (SMB) Header
JPWR1	24-pin ATX Power Supply Connector
JPWR2	8-pin Power Connector
JSD1, JSD2	SATA DOM Power Connectors
JSTBY1	Standby Power Header
JTPM1	Trusted Platform Module (TPM)/Port 80 Header
JUIDB1	Unit Identifier (UID) Switch
LAN1, LAN2	1GbE LAN Ports
M.2 PCI-E 3.0 x4	M.2 PCI-E 3.0 x4 Slot (Supports M-Key 2280 / 22110 and Intel Optane Memory)
MH10, MH11	M.2 Mounting Holes



Notes: The table above is continued on the next page.

Connector	Description
SLOT4, SLOT5	CPU PCI-E 3.0 x4 (in x8) Slots
SLOT6	CPU PCI-E 3.0 x8 (in x16) Slot
SP1	Onboard Buzzer
USB0/1	Back Panel Universal Serial Bus (USB) 2.0 Ports
USB2/3, USB4/5	Front Accessible USB 2.0 Headers
USB6/7	Back Panel USB 3.1 Gen 1 Ports
USB8/9	Front Accessible USB 3.1 Gen 1 Header
USB10	USB 3.1 Gen 1 Type-A Header
VGA	VGA Port

Motherboard Features

Motherboard Features	
CPU	
<ul style="list-style-type: none"> Supports an Intel Xeon E-2200/2100, 9th/8th Generation Core i3, Pentium, and Celeron (Socket H4 - LGA 1151) series processor with a thermal design power (TDP) of up to 95W and six cores 	
Memory	
<ul style="list-style-type: none"> Up to 128GB of unbuffered (UDIMM) DDR4 (288-pin) ECC memory with speeds of up to 2666MHz in four memory slots 	
 Note: Memory speed support depends on the processor used in the system.	
DIMM Size	
<ul style="list-style-type: none"> Up to 32GB at 1.2V 	
 Note: For the latest CPU/memory updates, please refer to our website at http://www.supernano.com/products/motherboard .	
Chipset	
<ul style="list-style-type: none"> Intel C242 	
Expansion Slots	
<ul style="list-style-type: none"> Two (2) PCI-Express 3.0 x4 (in x8) Slots (CPU SLOT4, CPU SLOT5) One (1) PCI-Express 3.0 x8 (in x16) Slot (CPU SLOT6) One (1) M.2 for PCI-Express 3.0 x4 (Supports M-Key 2280 / 22110 and Intel Optane Memory) 	
Network Controllers	
<ul style="list-style-type: none"> Intel i210 for Dual 1GbE BASE-T Ports One (1) Dedicated IPMI LAN located on the back I/O panel 	
Baseboard Management Controller (BMC)	
<ul style="list-style-type: none"> ASpeed AST2500 BMC 	
Graphics	
<ul style="list-style-type: none"> Graphics controller via ASpeed AST2500 BMC 	
I/O Devices	
<ul style="list-style-type: none"> Serial (COM) Port 	<ul style="list-style-type: none"> One (1) serial port on the back I/O panel (COM1) One (1) front accessible serial port header (COM2)
<ul style="list-style-type: none"> SATA 3.0 	<ul style="list-style-type: none"> Six (6) SATA 3.0 ports at 6Gb/s (I-SATA 0~5 with RAID 0, 1, 5, 10)
<ul style="list-style-type: none"> Video (VGA) Port 	<ul style="list-style-type: none"> One (1) VGA connection on the back I/O panel



Notes: The table above is continued on the next page.

Motherboard Features
<p>Peripheral Devices</p> <ul style="list-style-type: none"> • Two (2) USB 2.0 ports on the back I/O panel (USB0/1) • Two (2) USB 3.1 Gen 1 ports on the back I/O panel (USB6/7) • Two (2) front accessible USB 2.0 headers with two (2) USB connections each (USB2/3, USB4/5) • One (1) front accessible USB 3.1 Gen 1 header with two (2) USB connections (USB8/9) • One (1) USB 3.1 Gen 1 Type-A header (USB10)
<p>BIOS</p> <ul style="list-style-type: none"> • 256Mb AMI BIOS® SPI Flash BIOS • ACPI 6.0 or later, Plug and Play (PnP), BIOS rescue hot-key, SPI dual/quad speed support, riser card auto detection support, SMBIOS 2.7 or later
<p>Power Management</p> <ul style="list-style-type: none"> • ACPI power management • Power button override mechanism • Wake-on-LAN • Power-on mode for AC power recovery • Power supply monitoring
<p>System Health Monitoring</p> <ul style="list-style-type: none"> • Onboard voltage monitoring for +12V, +5V, +3.3V, CPU, Memory, VBAT, +5V stdby, +3.3V stdby, +1.8V PCH, +1.05V PCH, +1.0V PCH, CPU temperature, VRM temperature, PCH temperature, system temperature, and memory temperature • 4 CPU switch phase voltage regulator • CPU thermal trip support • Platform Environment Control Interface (PECI)
<p>Fan Control</p> <ul style="list-style-type: none"> • Fan status monitoring via IPMI connections • Dual cooling zones • Multi-fan speed control support through onboard BMC • Five (5) 4-pin fan headers
<p>System Management</p> <ul style="list-style-type: none"> • Trusted Platform Module (TPM) support • SuperDoctor® 5 • Watchdog, Non-maskable Interrupt (NMI), RoHs • Chassis intrusion header and detection • Server Platform Service
<p>LED Indicators</p> <ul style="list-style-type: none"> • CPU/system overheat LED • Power/suspend-state indicator LED • Fan failed LED • UID/remote UID • HDD activity LED • LAN activity LED



Notes: The table above is continued on the next page.

Motherboard Features

Dimensions

- 9.6" (W) x 9.6" (L) (243.8mm x 243.8mm)



Note 1: The CPU maximum thermal design power (TDP) is subject to chassis and heatsink cooling restrictions. For proper thermal management, please check the chassis and heatsink specifications for proper CPU TDP sizing.

Note 2: For IPMI configuration instructions, please refer to the Embedded IPMI Configuration User's Guide available at <http://www.supermicro.com/support/manuals/>.

Note 3: Starting in 2020, Supermicro ships standard products with a unique password that can be found on a label on the motherboard. For products shipped before 2020, the manufacturer default username is ADMIN and the password is ADMIN. For general documentation and information on IPMI, please visit our website at: <https://www.supermicro.com/en/solutions/management-software/bmc-resources>.

Figure 1-3.
C242 System Block Diagram

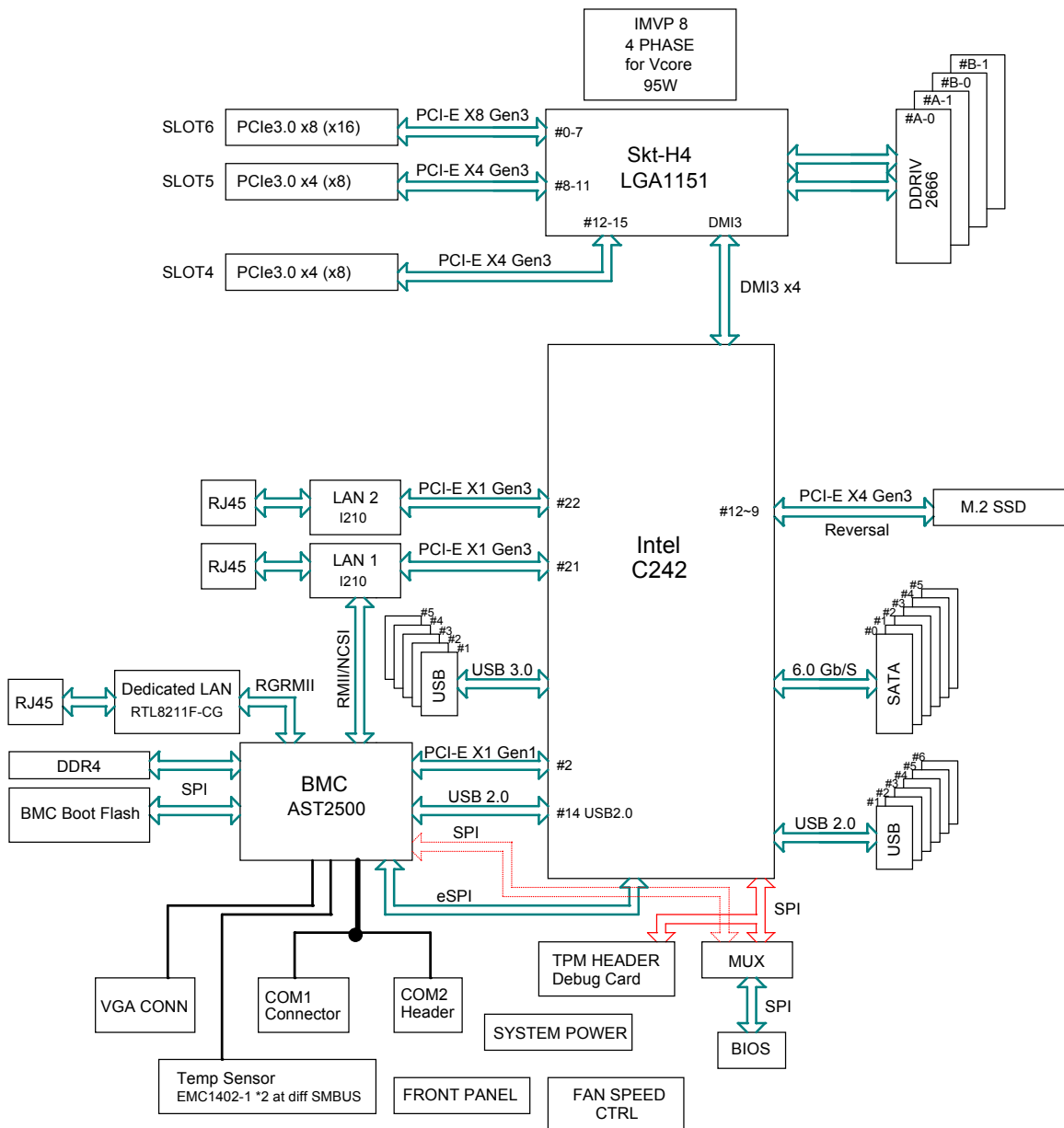

Note: This is a general block diagram and may not exactly represent the features on your motherboard. See the previous pages for the actual specifications of your motherboard.

1.2 Processor and Chipset Overview

Built upon the functionality and capability of the Intel Xeon E-2200/2100, 9th/8th Generation Core i3, Pentium, and Celeron series processor (Socket H4 - LGA 1151) and the Intel C242 chipset, the X11SCL-F motherboard provides optimized system performance, efficient power management, and features based on cutting edge technology to address the needs of next-generation computer users. The X11SCL-F offers maximum I/O flexibility and data reliability in a 14-nm process architecture and is ideal for SMB, embedded storage solutions, and cloud-computing platforms.

The Intel Xeon E-2200/2100, 9th/8th Generation Core i3, Pentium, and Celeron processor and the C242 chipset support the following features:

- DDR4 288-pin memory support
- Support of SMBus speeds of up to 400KHz for BMC connectivity
- Improved I/O capabilities to high-storage-capacity configurations
- SPI Enhancements
- BMC supports remote management, virtualization, and the security package for enterprise platforms

1.3 Special Features

Recovery from AC Power Loss

The Basic I/O System (BIOS) provides a setting that determines how the system will respond when AC power is lost and then restored to the system. You can choose for the system to remain powered off (in which case you must press the power switch to turn it back on), or for it to automatically return to the power-on state. See the Advanced BIOS Setup section for this setting. The default setting is **Last State**.

1.4 System Health Monitoring

Onboard Voltage Monitors

An onboard voltage monitor will continuously scan the voltages of the onboard chipset, memory, CPU, and battery. Once a voltage becomes unstable, a warning is given or an error message is sent to the screen. The user can adjust the voltage thresholds to define the sensitivity of the voltage monitor. Real time voltage levels are displayed in IPMI.

Fan Status Monitor with Firmware Control

The system health monitor embedded in the BMC chip can check the RPM status of the cooling fans. The CPU and chassis fans are controlled via IPMI.

Environmental Temperature Control

System Health sensors in the BMC monitor the temperatures and voltage settings of onboard processors and the system in real time via the IPMI interface. Whenever the temperature of the CPU or the system exceeds a user-defined threshold, system/CPU cooling fans will be turned on to prevent the CPU or the system from overheating.



Note: To avoid possible system overheating, please be sure to provide adequate air-flow to your system.

System Resource Alert

This feature is available when used with SuperDoctor 5[®]. SuperDoctor 5 is used to notify the user of certain system events. For example, you can configure SuperDoctor 5 to provide you with warnings when the system temperature, CPU temperatures, voltages, and fan speeds go beyond a predefined range.

1.5 ACPI Features

ACPI stands for Advanced Configuration and Power Interface. The ACPI specification defines a flexible and abstract hardware interface that provides a standard way to integrate power management features throughout a computer system, including its hardware, operating system and application software. This enables the system to automatically turn on and off peripherals such as network cards, hard disk drives, and printers.

In addition to enabling operating system-directed power management, ACPI also provides a generic system event mechanism for Plug and Play, an operating system-independent interface for configuration control. ACPI leverages the Plug and Play BIOS data structures while providing a processor architecture-independent implementation that is compatible with Windows Server 2016.

1.6 Power Supply

As with all computer products, a stable power source is necessary for proper and reliable operation. It is even more important for processors that have high CPU clock rates where noisy power transmission is present.

The X11SCL-F motherboard accommodates a 24-pin ATX power supply. Although most power supplies generally meet the specifications required by the CPU, some are inadequate. In addition, one 12V 8-pin power connection is also required to ensure adequate power to the system.

Warning: To avoid damaging the power supply or the motherboard, be sure to use power supplies that contain 24-pins and 8-pins, respectively. Be sure to connect the power supplies to the 24-pin power connector (JPWR1), and the 8-pin power connector (JPWR2) on the motherboard. Failure in doing so may void the manufacturer warranty on your power supply and motherboard.

It is strongly recommended that you use a high quality power supply that meets ATX power supply Specification 2.02 or above and is SSI compliant. (For more information, please refer to the website at <http://www.ssiforum.org/>).

1.7 Serial Port

The X11SCL-F motherboard supports two serial communication connections. COM Port 1 and COM Header 2 can be used for input/output. The UART provides legacy speeds with a baud rate of up to 115.2 Kbps as well as an advanced speed with baud rates of 250 K, 500 K, or 1 Mb/s, which support high-speed serial communication devices.

Chapter 2

Installation

2.1 Static-Sensitive Devices

Electrostatic Discharge (ESD) can damage electronic components. To avoid damaging your system board, it is important to handle it very carefully. The following measures are generally sufficient to protect your equipment from ESD.

Precautions

- Use a grounded wrist strap designed to prevent static discharge.
- Touch a grounded metal object before removing the board from the antistatic bag.
- Handle the motherboard by its edges only. Do not touch its components, peripheral chips, memory modules, or gold contacts.
- When handling chips or modules, avoid touching their pins.
- Put the motherboard and peripherals back into their antistatic bags when not in use.
- For grounding purposes, make sure that your computer chassis provides excellent conductivity between the power supply, the case, the mounting fasteners, and the motherboard.
- Use only the correct type of onboard CMOS battery. Do not install the onboard battery upside down to avoid possible explosion.

Unpacking

The motherboard is shipped in antistatic packaging to avoid static damage. When unpacking the motherboard, make sure that the person handling it is static protected.

2.2 Motherboard Installation

All motherboards have standard mounting holes to fit different types of chassis. Make sure that the locations of all the mounting holes for both the motherboard and the chassis match. Although a chassis may have both plastic and metal mounting fasteners, metal ones are highly recommended because they ground the motherboard to the chassis. Make sure that the metal standoffs click in or are screwed in tightly.

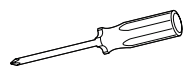

Phillips Screwdriver
(1)



Phillips Screws
(7)



Standoffs (7)
Only if Needed

Tools Needed

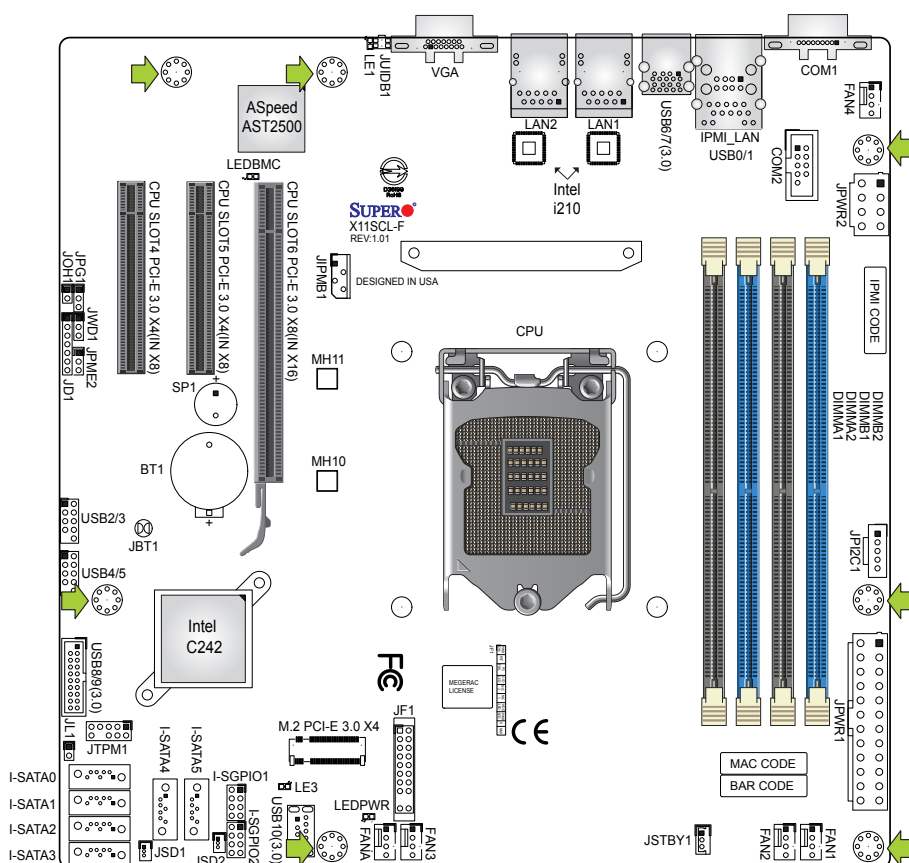

Location of Mounting Holes



- Note:**
- 1) To avoid damaging the motherboard and its components, please do not use a force greater than 8 lbf-in on each mounting screw during motherboard installation.
 - 2) Some components are very close to the mounting holes. Please take precautionary measures to avoid damaging these components when installing the motherboard to the chassis.

Installing the Motherboard

1. Install the I/O shield into the back of the chassis, if applicable.

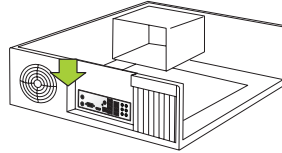

2. Locate the mounting holes on the motherboard. See the previous page for the location.

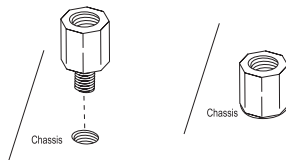

3. Locate the matching mounting holes on the chassis. Align the mounting holes on the motherboard against the mounting holes on the chassis.

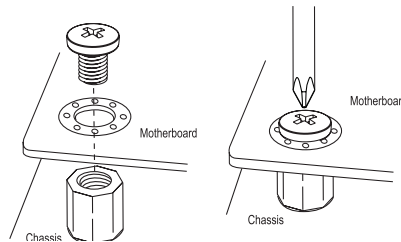

4. Install standoffs in the chassis as needed.
5. Install the motherboard into the chassis carefully to avoid damaging other motherboard components.
6. Using the Phillips screwdriver, insert a pan head #6 screw into a mounting hole on the motherboard and its matching mounting hole on the chassis.
7. Repeat Step 5 to insert #6 screws into all mounting holes.
8. Make sure that the motherboard is securely placed in the chassis.

 **Note:** Images displayed are for illustration only. Your chassis or components might look different from those shown in this manual.

2.3 Processor and Heatsink Installation

Warning: When handling the processor package, avoid placing direct pressure on the LGA lands (gold contacts) of the CPU or CPU socket. Improper installation or socket misalignment can cause serious damage to the CPU or motherboard, which may result in RMA repairs. Please read and follow all instructions thoroughly before installing your CPU and heatsink.



Important:

- Always connect the power cord last, and unplug it before adding, removing, or changing any hardware components. You must install the processor into the CPU socket before you install the heatsink.
- If you buy a CPU separately, make sure that you use an Intel-certified multi-directional heatsink only.
- Install the motherboard into the chassis before you install the CPU heatsink.
- When receiving a motherboard without a pre-installed processor, check that a plastic protective cover is on the CPU socket and none of the socket pins are bent. If they are, contact your retailer.
- Refer to the Supermicro website for updates on CPU support.

Installing the LGA 1151 Processor

1. Press the load lever down to release the load plate from its locking position.

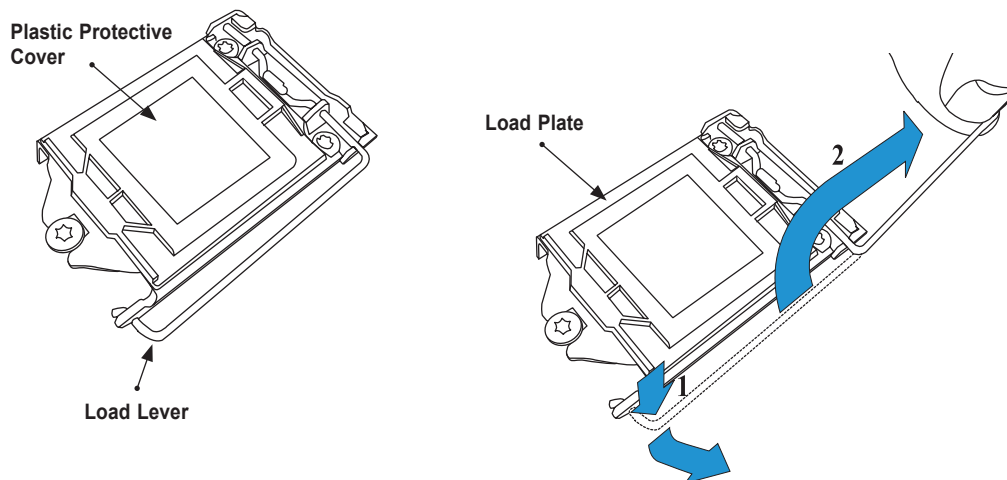

2. Gently lift the load lever to open the load plate. Remove the plastic protective cover. Do not touch the CPU socket contacts.

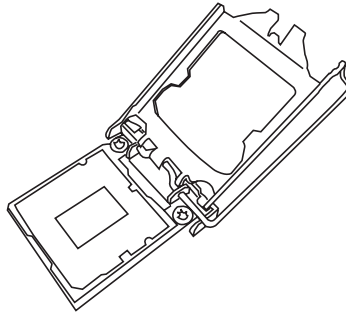

3. Locate the triangle on the CPU and CPU socket, which indicates the location of Pin 1. Holding the CPU by the edges with your thumb and index finger, align the triangle on the CPU with the triangle on the socket. The CPU keys (the semi-circle cutouts) may also be aligned against the socket keys as a guide.

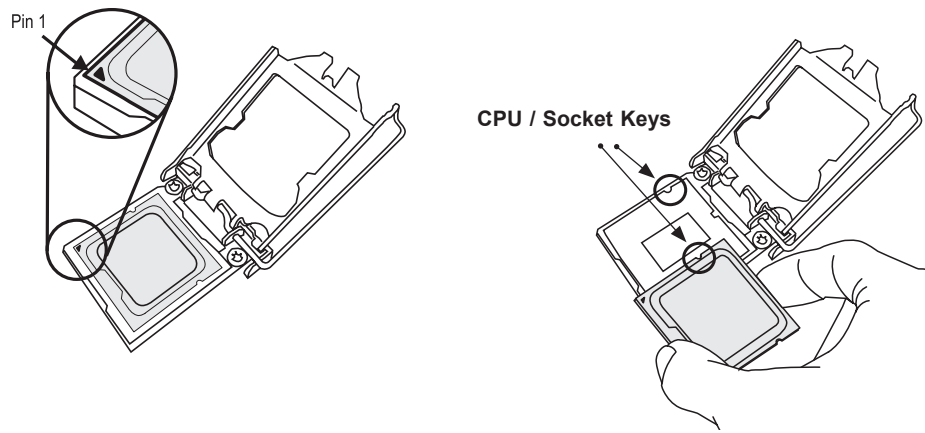

4. Carefully lower the CPU straight down into the socket. Do not drop the CPU on the socket, or move it horizontally or vertically to avoid damaging the CPU or socket. Inspect the four corners of the CPU to make sure that the CPU is properly installed.

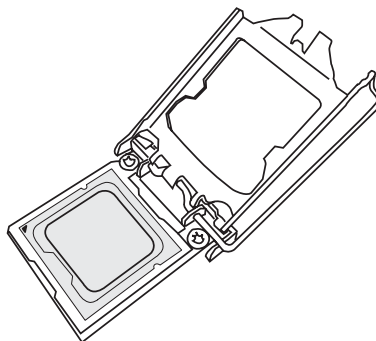

5. Close the load plate, then gently push down the load lever into its locking position.

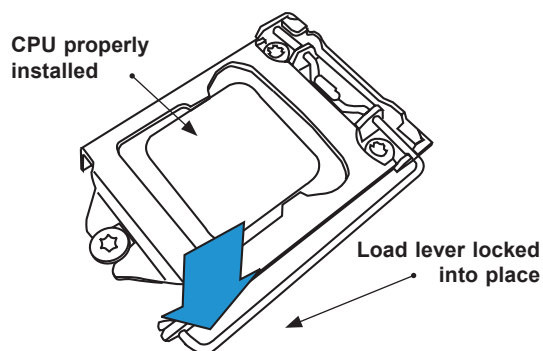

 **Note:** You can only install the CPU in one direction. Make sure it is properly inserted into the socket before closing the load plate. If it doesn't close properly, do not force it as it may damage your CPU. Instead, open the load plate again and double-check that the CPU is properly aligned.

Installing an Active CPU Heatsink with Fan

1. Locate the CPU fan header on the motherboard (FAN1: CPU FAN).
2. Position the heatsink so that its wires are closest to the CPU fan header and are not interfering with other components.
3. Inspect the CPU fan wires to make sure they are routed through the bottom of the heatsink.
4. Remove the thin layer of protective film from the heatsink. CPU overheating may occur if the protective film is not removed from the heatsink.
5. Apply the proper amount of thermal grease on the CPU. If your heatsink came with a thermal pad, please ignore this step.

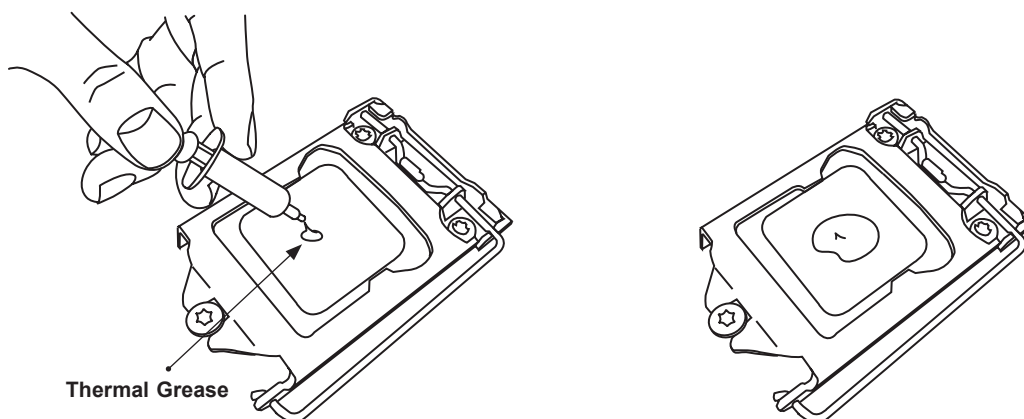

- Align the four heatsink fasteners with the mounting holes on the motherboard. Gently push down the fasteners in a diagonal order (Example: #1 and #2, then #3 and #4) into the mounting holes until you hear a click. Then lock the fasteners by turning each one 90° clockwise.

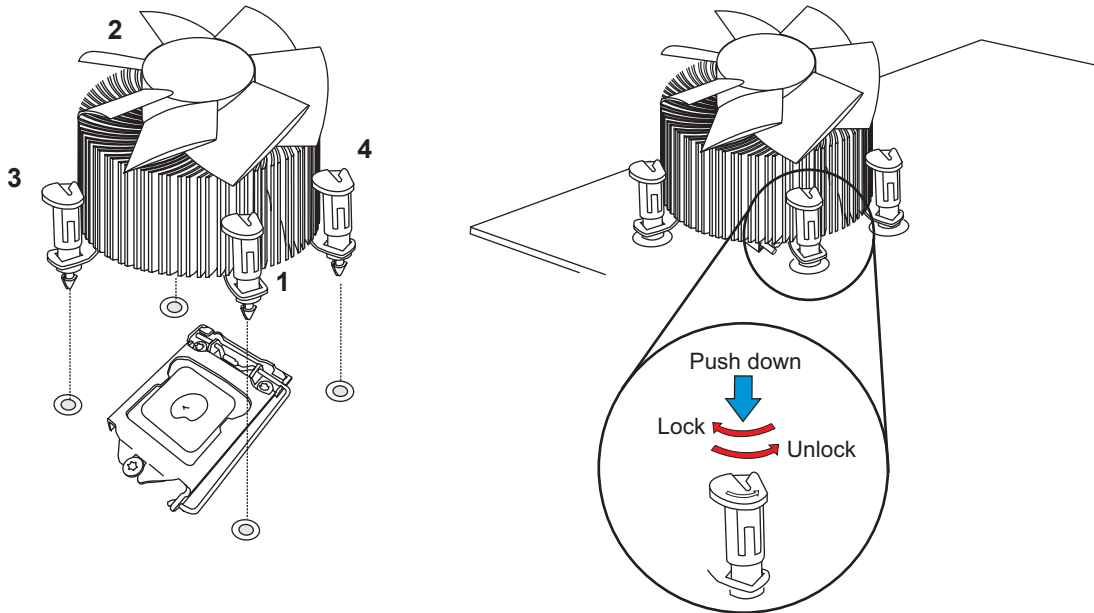

- Once all four fasteners are secured, connect the heatsink fan wire connector to the CPU fan header.

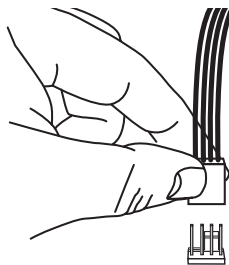

Removing the Heatsink

 **Note:** We do not recommend that the CPU or heatsink be removed. However, if you do need to remove the heatsink, please follow the instructions below to remove the heatsink and prevent damage done to the CPU or other components.

1. Unplug the power connector from the power supply.
2. Disconnect the heatsink fan connector from the CPU fan header.
3. Gently press down each fastener cap and turn them 90° counter clockwise, then pull the fasteners upwards to loosen them.
4. Remove the heatsink from the CPU.

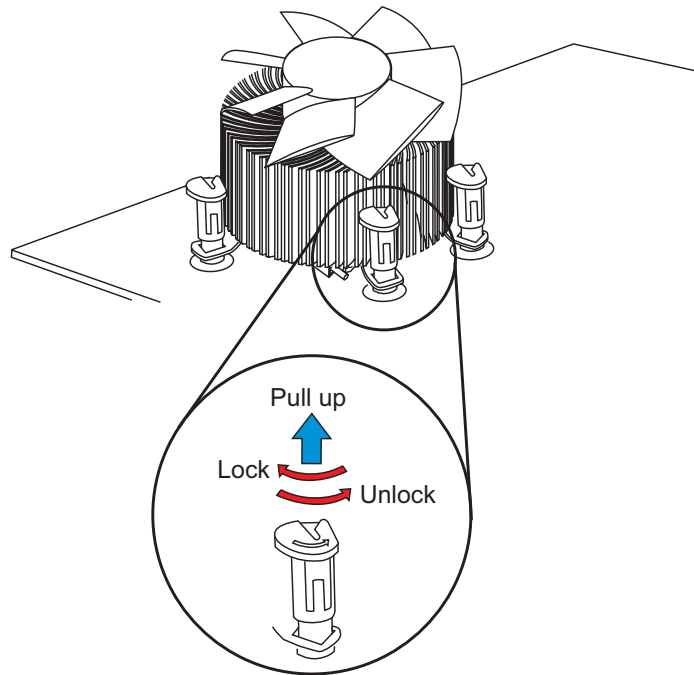

2.4 Memory Support and Installation

 **Note:** Check the Supermicro website for recommended memory modules. Exercise extreme care when installing or removing DIMM modules to prevent any damage.

Memory Support

The X11SCL-F supports up to 128GB of unbuffered (UDIMM) DDR4 (288-pin) ECC memory (2-DIMM per channel) with speeds of up to 2666MHz in four memory slots. Refer to the tables below for the recommended DIMM population order and additional memory information.

1 CPU, 4-DIMM Slots	
Number of DIMMs	Memory Population Sequence
1	DIMMB2
2	DIMMB2 / DIMMA2
3 (Unbalanced: Not Recommended)	DIMMB2 / DIMMA2 / DIMMB1
4	DIMMB2 / DIMMBA2 / DIMMB1/ DIMMA1

DIMM Type	Ranks Per DIMM and Data Width	DIMM Capacity (GB)			Speed (MT/s), Voltage (V), Slot Per Channel (SPC), and DIMM Per Channel (DPC)	
		DRAM Density			2 Slots Per Channel	
		4Gb	8Gb	16Gb	1DPC	2DPC
Unbuffered DDR4 ECC	SR	16GB (4x 4GB DIMMs)	32GB (4x 8GB DIMMs)	128GB (4x 32 GB DIMMs)	2666	2666
	DR	32GB (4x 8GB DIMMs)	64GB (4x 16GB DIMMs)	128GB (4x 32GB DIMMs)		

General Guidelines for Optimizing Memory Performance

- The blue slots must be populated first.
- Always use DDR4 memory of the same type, size, and speed.
- Mixed DIMM speeds can be installed. However, all DIMMs will run at the speed of the slowest DIMM.
- The motherboard will support odd-numbered modules. However, to achieve the best memory performance, a balanced memory population is recommended.

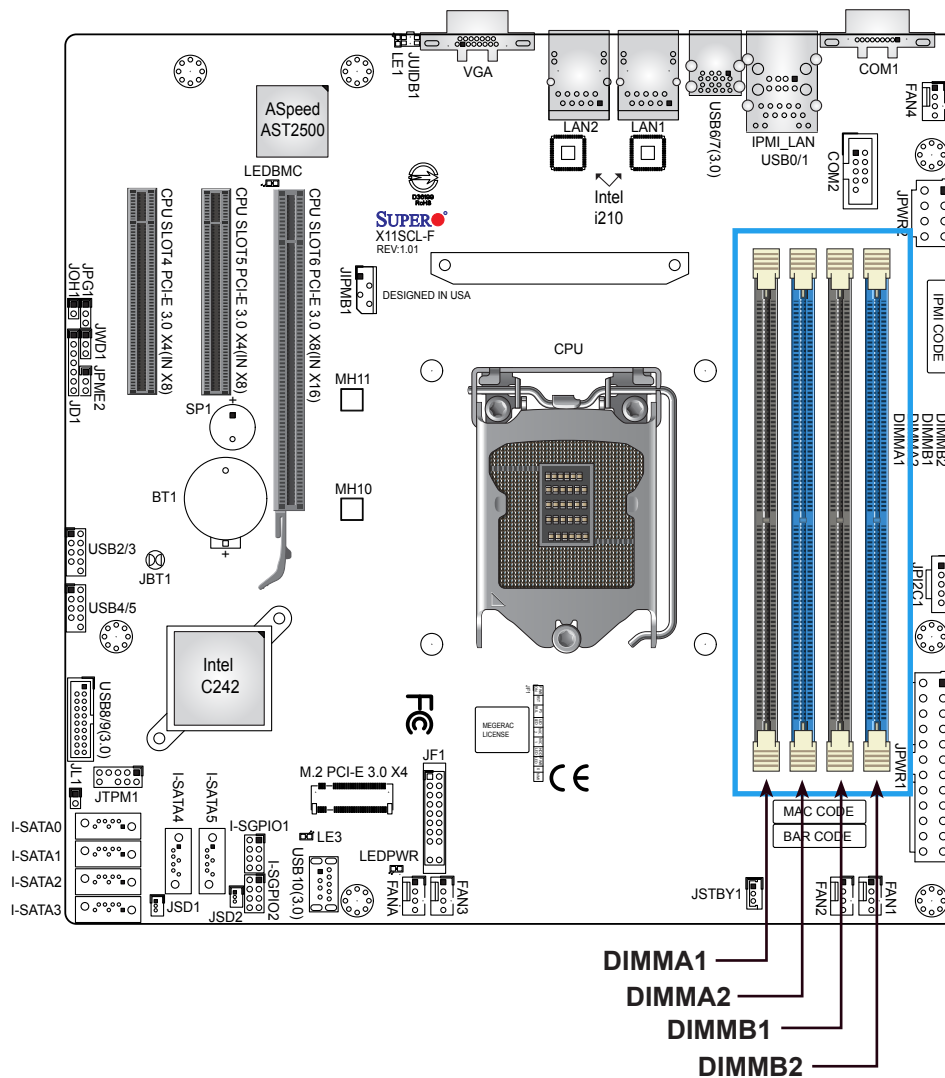

DIMM Installation

1. Insert the desired number of DIMMs into the memory slots based on the recommended DIMM population table on page 29.
2. Push the release tabs outwards on both ends of the DIMM slot to unlock it.
3. Align the key of the DIMM module with the receptive point on the memory slot.
4. Align the notches on both ends of the module against the receptive points on the ends of the slot.
5. Press the notches on both ends of the module straight down into the slot until the module snaps into place.
6. Press the release tabs to the lock positions to secure the DIMM module into the slot.

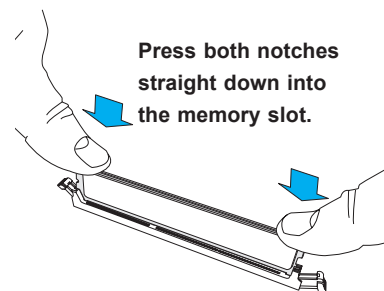
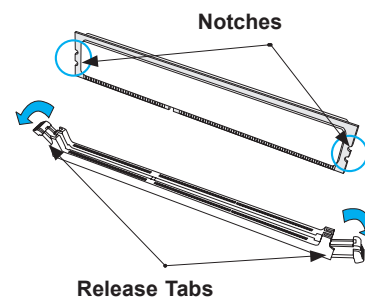
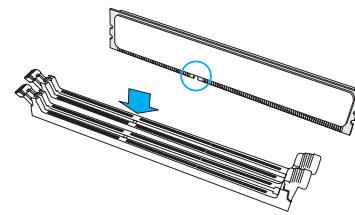
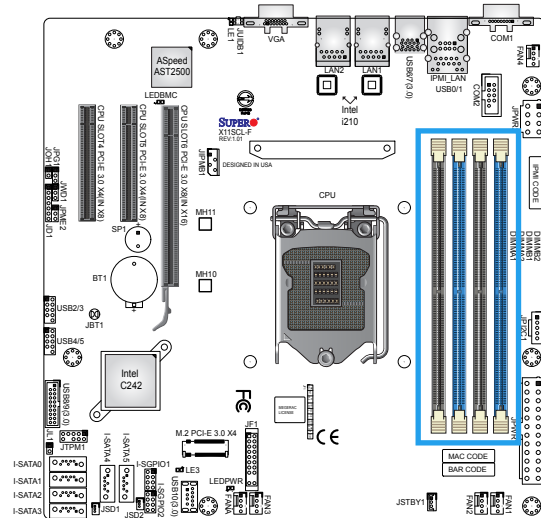

DIMM Removal

Press both release tabs on the ends of the DIMM socket to unlock it. Once the DIMM module is loosened, remove it from the memory slot.

2.5 Rear I/O Ports

See the layout below for the locations and descriptions of the various I/O ports on the rear of the motherboard.

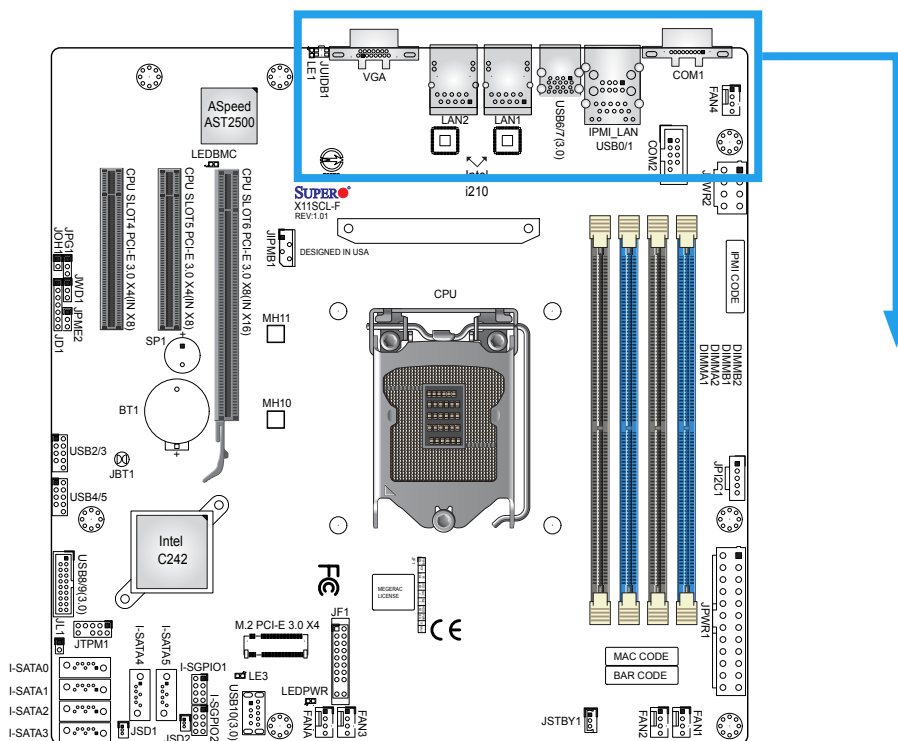

Back I/O Panel Port Locations and Definitions

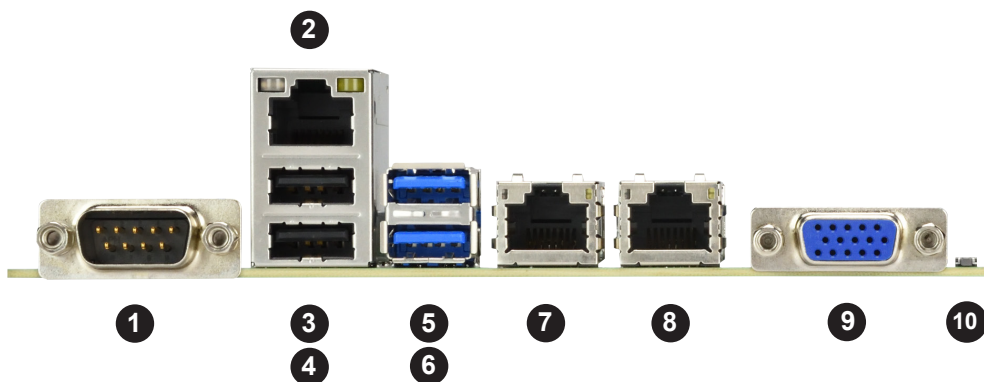

#	Description	#	Description
1	COM1	6	USB6 (USB 3.1 Gen 1)
2	Dedicated IPMI LAN	7	LAN1
3	USB1	8	LAN2
4	USB0	9	VGA Port
5	USB7 (USB 3.1 Gen 1)	10	UID Switch

COM Port

There is one COM port (COM1) on the back I/O panel and one COM header (COM2) on the motherboard. The COM port and header provide serial communication support.

COM Port Pin Definitions			
Pin#	Definition	Pin#	Definition
1	DCD	6	DSR
2	RXD	7	RTS
3	TXD	8	CTS
4	DTR	9	RI
5	GND	10	N/A

VGA Port

The onboard VGA port is located next to LAN2 on the back I/O panel. Use this connection for VGA display.

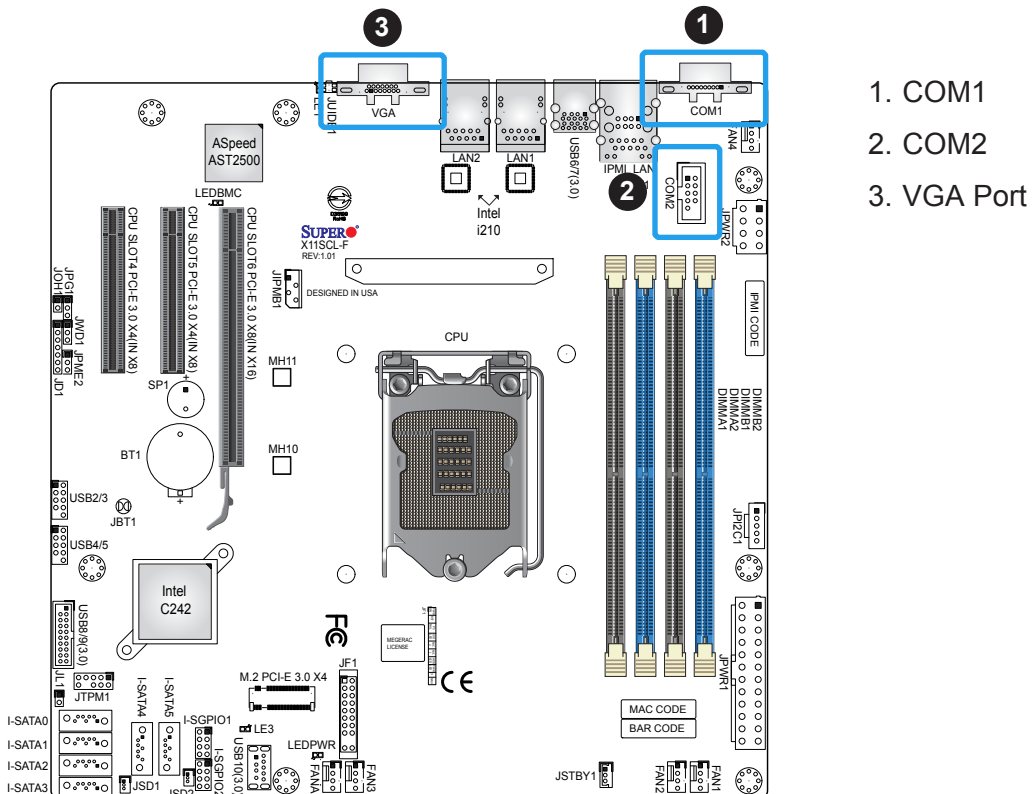

Universal Serial Bus (USB) Ports

There are two USB 2.0 ports (USB0/1) and two USB 3.1 Gen 1 ports (USB6/7) located on the back I/O panel. The motherboard also has two front access USB 2.0 headers (USB2/3, USB4/5) and one front access USB 3.1 Gen 1 header (USB8/9). The USB10 header is USB 3.1 Gen 1 Type-A. The onboard headers can be used to provide front side USB access with a cable (not included).

Back Panel USB 0/1 (2.0) Pin Definitions			
Pin#	Definition	Pin#	Definition
1	+5V	5	+5V
2	USB_N	6	USB_N
3	USB_P	7	USB_P
4	GND	8	GND

Front Panel USB 2/3, 4/5 (2.0) Pin Definitions			
Pin#	Definition	Pin#	Definition
1	+5V	2	+5V
3	USB_N	4	USB_N
5	USB_P	6	USB_P
7	GND	8	GND
9	Key	10	NC

Back Panel USB 6/7 (USB 3.1 Gen 1) Pin Definitions			
Pin#	Definition	Pin#	Definition
A1	VBUS	B1	Power
A2	D-	B2	USB_N
A3	D+	B3	USB_P
A4	GND	B4	GND
A5	Stda_SSRX-	B5	USB3_RN
A6	Stda_SSRX+	B6	USB3_RP
A7	GND	B7	GND
A8	Stda_SSTX-	B8	USB3_TN
A9	Stda_SSTX+	B9	USB3_TP

Front Panel USB 8/9 (USB 3.1 Gen 1) Pin Definitions			
Pin#	Definition	Pin#	Definition
1	VBUS	19	Power
2	Stda_SSRX-	18	USB3_RN
3	Stda_SSRX+	17	USB3_RP
4	GND	16	GND
5	Stda_SSTX-	15	USB3_TN
6	Stda_SSTX+	14	USB3_TP
7	GND	13	GND
8	D-	12	USB_N
9	D+	11	USB_P
10		x	

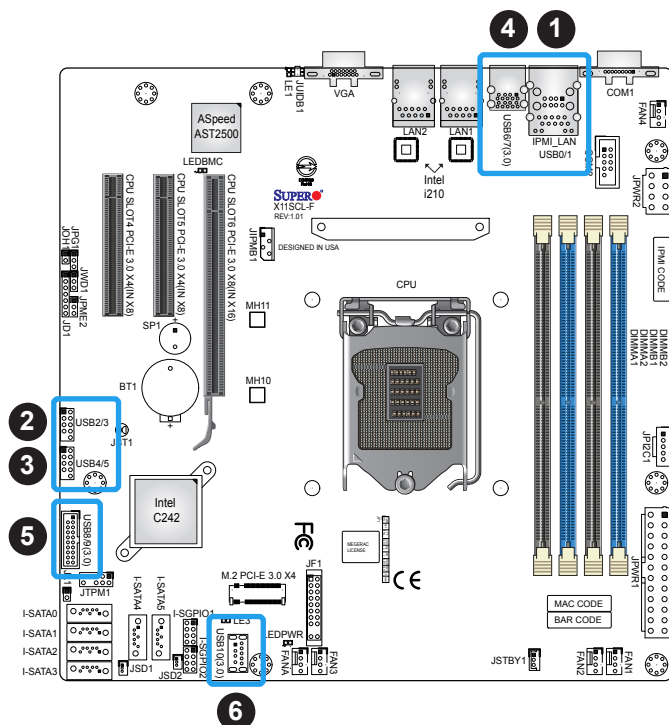

Type A USB 10 (USB 3.1 Gen 1) Pin Definitions			
Pin#	Definition	Pin#	Definition
1	VBUS	5	SSRX-
2	USB_N	6	SSRX+
3	USB_P	7	GND
4	GND	8	SSTX-
		9	SSTX+

1. USB0/1
2. USB2/3
3. USB4/5
4. USB6/7
5. USB8/9
6. USB10

LAN Ports

Two Gigabit Ethernet ports (LAN1, LAN2) are located on the back I/O panel. In addition, a dedicated IPMI LAN is located above USB0/1. All of these ports accept RJ45 cables. Please refer to the LED Indicator section for LAN LED information.

LAN Ports Pin Definition			
Pin#	Definition	Pin#	Definition
1	GND	9	TD1+
2	VCC	10	TD1-
3	TD4+	11	Link 1000 LED
4	TD4-	12	Link 100 LED
5	TD3+	13	P3V3_Dual
6	TD3-	14	Act LED
7	TD2+	15	GND
8	TD2-	16	GND

IPMI LAN Pin Definition			
Pin#	Definition	Pin#	Definition
9		19	GND
10	TD0+	20	Act LED (Yellow)
11	TD0-	21	Link 100 LED (Green)
12	TD1+	22	Link 1000 LED (Amber)
13	TD1-	23	SGND
14	TD2+	24	SGND
15	TD2-	25	SGND
16	TD3+	26	SGND
17	TD3-		
18	GND		

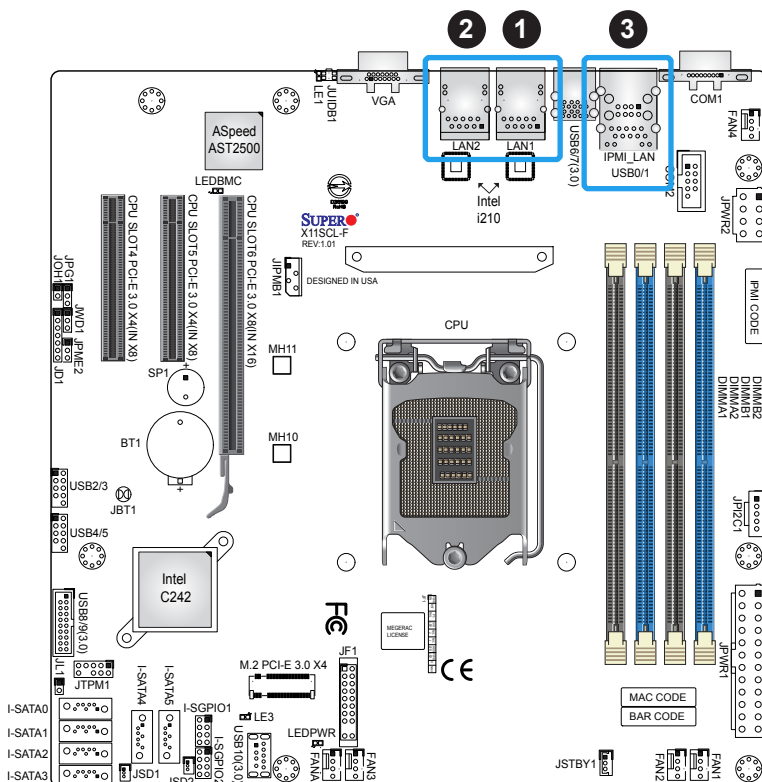

Unit Identifier Switch/UID LED Indicator

A Unit Identifier (UID) switch and an LED indicator are located on the motherboard. The UID switch is located at JUIDB1, which is next to the VGA port on the back panel. The UID LED (LE1) is located next to the UID switch. When you press the switch, the LED will be turned on, which provides easy identification of a system unit that may be in need of service. Press the switch again to turn off the LED indicator.

 **Note:** UID can also be triggered via IPMI on the motherboard. For more information on IPMI, please refer to the IPMI User's Guide posted on our website: <https://www.supermicro.com/support/manuals/>

UID Switch Pin Definitions	
Pin#	Definition
1	GND
2	GND
3	Button In
4	Button In

UID LED Pin Definitions	
Color	Status
Blue	On
	Unit Identified

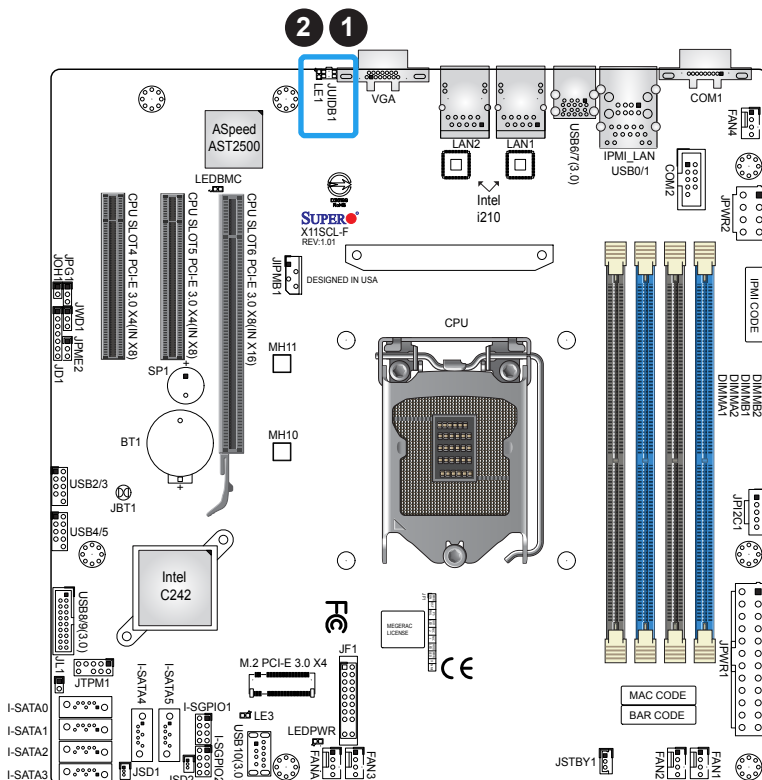

1. UID Switch
2. UID LED

2.6 Front Control Panel

JF1 contains header pins for various buttons and indicators that are normally located on a control panel at the front of the chassis. These connectors are designed specifically for use with Supermicro chassis. See the figure below for the descriptions of the front control panel buttons and LED indicators.

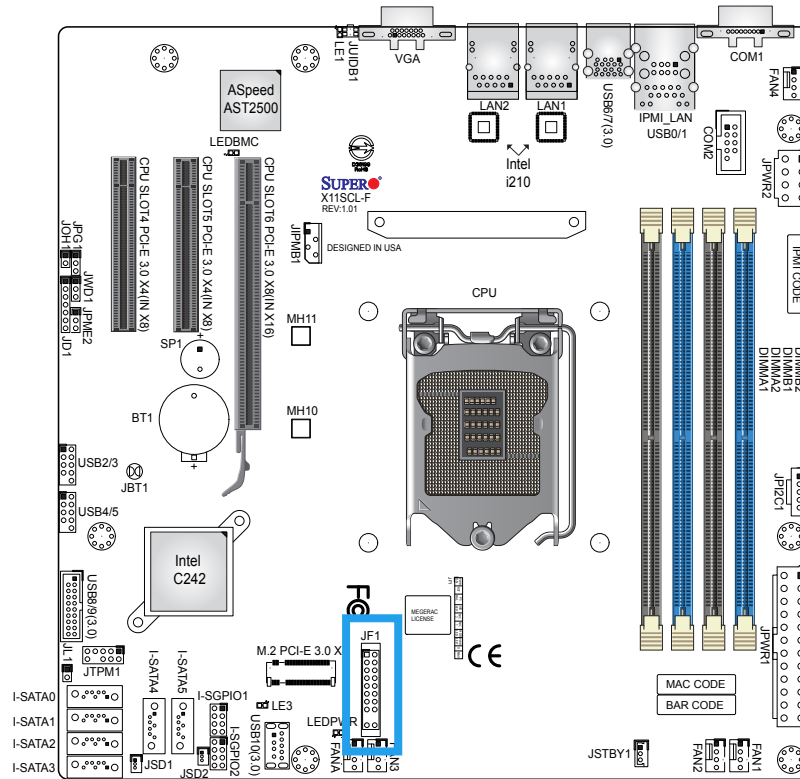

Figure 2-1. JF1 Header Pins

	1	2	
PWR } Power Button	○	○	Ground
Reset } Reset Button	○	○	Ground
3.3V	○	○	Power Fail LED
UID LED	○	○	OH/Fan Fail LED
3.3V Stby	○	○	NIC2 Active LED
3.3V Stby	○	○	NIC1 Active LED
UID SW	○	○	HDD LED
3.3V	○	○	PWR LED
X	○	○	X
NMI	○	○	Ground
	19	20	

Power Button

The Power Button connection is located on pins 1 and 2 of JF1. Momentarily contacting both pins will power on/off the system. This button can also be configured to function as a suspend button (with a setting in the BIOS - see Chapter 4). To turn off the power when the system is in suspend mode, press the button for four seconds or longer. Refer to the table below for pin definitions.

Power Button Pin Definitions (JF1)	
Pin#	Definition
1	Signal
2	GND

Reset Button

The Reset Button connection is located on pins 3 and 4 of JF1. Attach it to a hardware reset switch on the computer case to reset the system. Refer to the table below for pin definitions.

Reset Button Pin Definitions (JF1)	
Pin#	Definition
3	Reset
4	GND

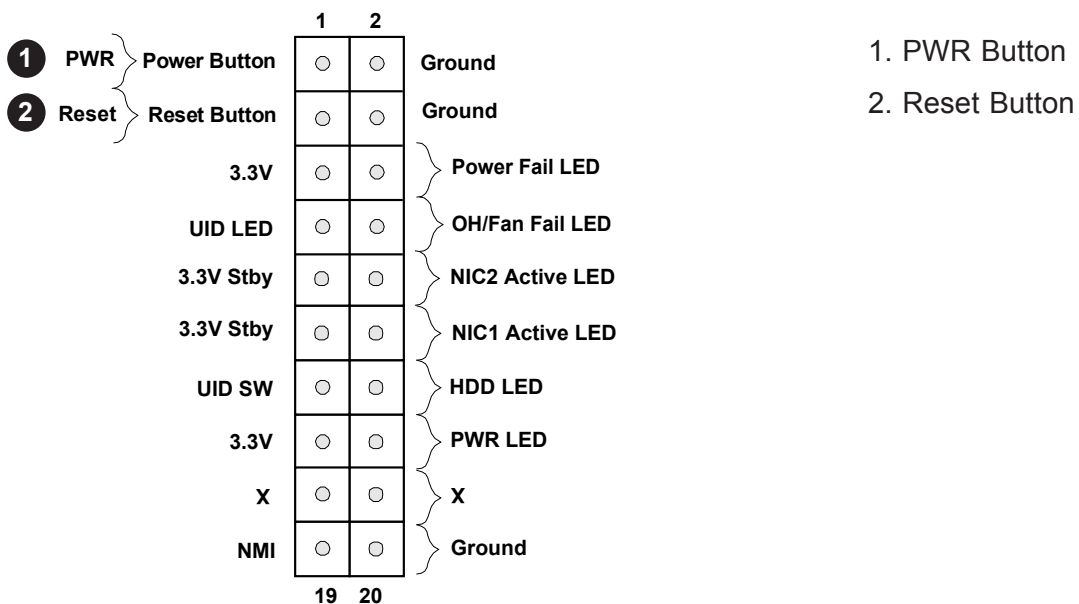

Power Fail LED

The Power Fail LED connection is located on pins 5 and 6 of JF1. Refer to the table below for pin definitions.

Power Fail LED Pin Definitions (JF1)	
Pin#	Definition
5	3.3V
6	PWR Supply Fail

Overheat/Fan Fail and UID LED

Connect an LED cable to pins 7 and 8 of the Front Control Panel to use the Overheat/Fan Fail LED connections. The LED on pin 8 provides warnings of overheat or fan failure. Refer to the tables below for pin definitions.

OH/Fan Fail Indicator Status	
State	Definition
Off	Normal
On	Overheat
Flashing	Fan Fail

OH/Fan Fail LED Pin Definitions (JF1)	
Pin#	Definition
7	UID LED (Blue)
8	OH/FAN Fail LED

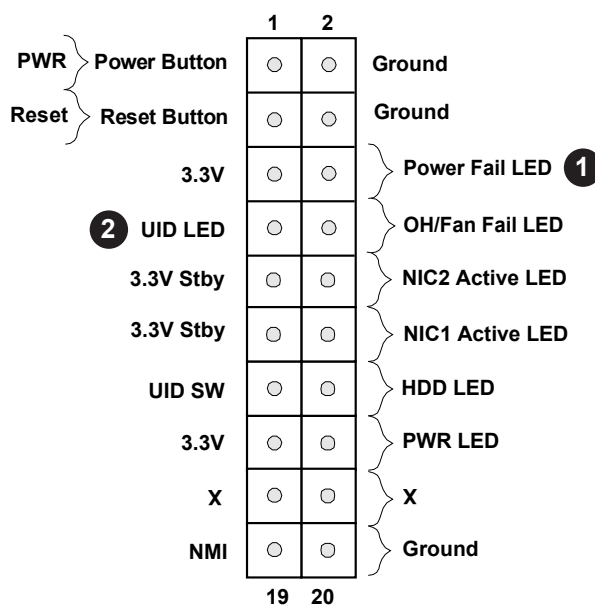

1. Power Fail LED
2. UID/OH/Fan Fail LED

NIC1/NIC2 (LAN1/LAN2)

The Network Interface Controller (NIC) LED connection for LAN port 1 is located on pins 11 and 12 of JF1, and LAN port 2 is on pins 9 and 10. Attach the NIC LED cables here to display network activity. Refer to the table below for pin definitions.

LAN1/LAN2 LED Pin Definitions (JF1)	
Pins	Definition
9	VCC
10	NIC2 Link/Active LED
11	VCC
12	NIC1 Link/Active LED

HDD LED/UID Switch

The HDD LED/UID Switch connection is located on pins 13 and 14 of JF1. Attach a cable to pin 14 to show hard drive activity status. Attach a cable to pin 13 to use the UID switch. Refer to the table below for pin definitions.

HDD LED/UID Switch Pin Definitions (JF1)	
Pin#	Definition
13	3.3V Stby/UID SW
14	HDD Active

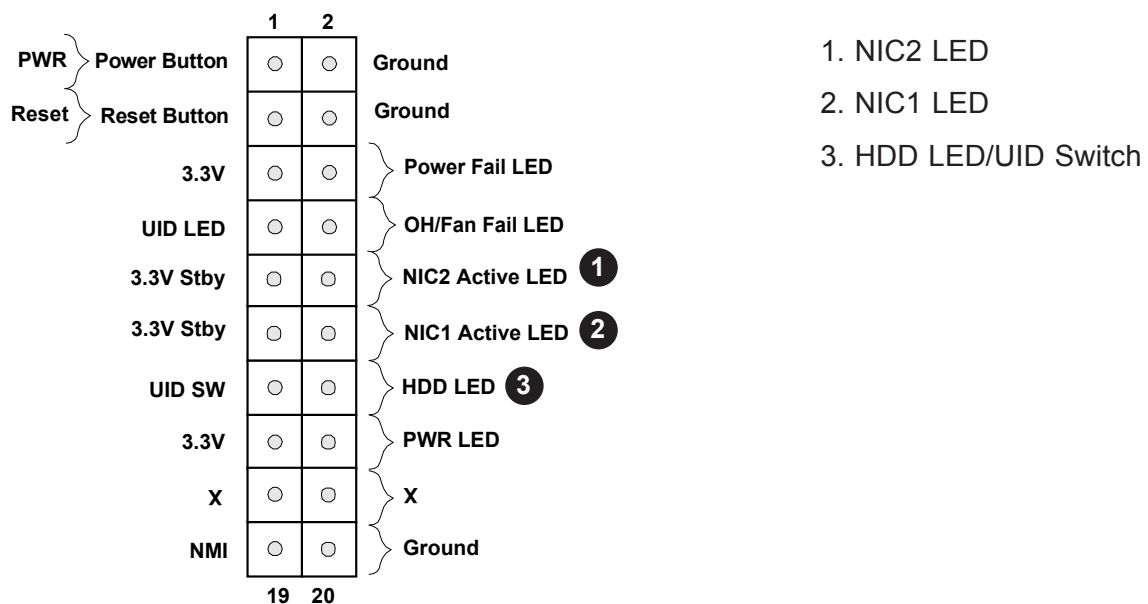

Power LED

The Power LED connection is located on pins 15 and 16 of JF1. Refer to the table below for pin definitions.

Power LED Pin Definitions (JF1)	
Pin#	Definition
15	3.3V
16	PWR LED

NMI Button

The non-maskable interrupt (NMI) button header is located on pins 19 and 20 of JF1. Refer to the table below for pin definitions.

NMI Button Pin Definitions (JF1)	
Pin#	Definition
19	Control
20	GND

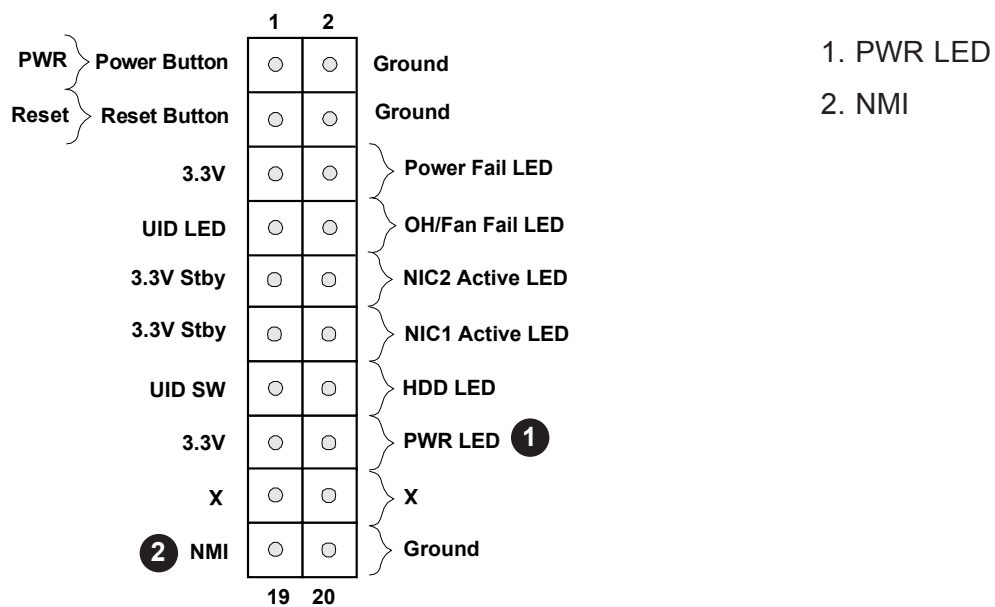

2.7 Connectors

Power Connections

ATX Power Supply Connector

The primary 24-pin power supply connector (JPWR1) meets the ATX SSI EPS 12V specification. An 8-pin (JPWR2) processor power connector must also be connected to your power supply.

ATX Power 24-pin Connector Pin Definitions			
Pin#	Definition	Pin#	Definition
13	+3.3V	1	+3.3V
14	NC	2	+3.3V
15	GND	3	GND
16	PS_ON	4	+5V
17	GND	5	GND
18	GND	6	+5V
19	GND	7	GND
20	Res (NC)	8	PWR_OK
21	+5V	9	5VSB
22	+5V	10	+12V
23	+5V	11	+12V
24	GND	12	+3.3V

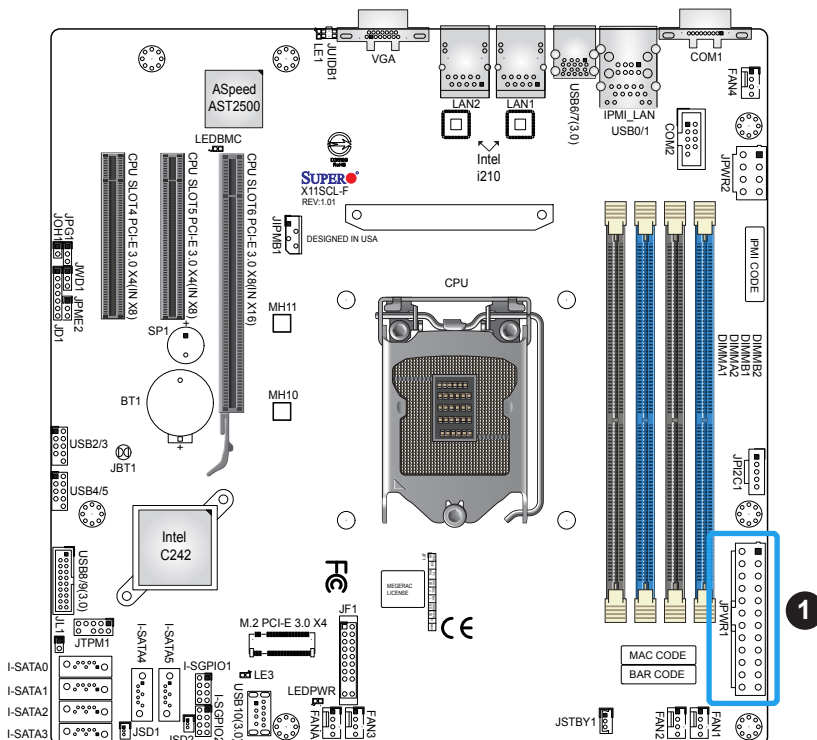

1. 24-pin ATX PWR

8-Pin Power Connector

JPWR2 is an 8-pin 12V DC power input for the CPU that must be connected to the power supply. Refer to the table below for pin definitions.

8-pin Power Pin Definitions	
Pin#	Definition
1 - 4	GND
5 - 8	P12V (12V Power)



Important: To provide adequate power supply to the motherboard, be sure to connect the 24-pin ATX PWR and the 8-pin PWR connectors to the power supply. Failure to do so may void the manufacturer warranty on your power supply and motherboard.

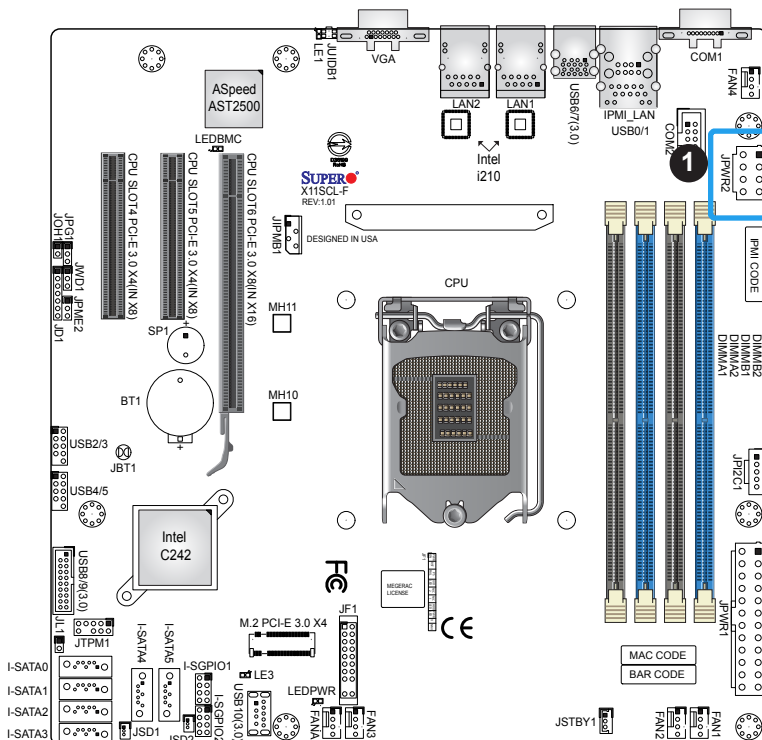

1. 8-pin PWR

Headers

Fan Headers

There are five 4-pin fan headers (FAN1 ~ FAN4, FANA) on the motherboard. All these 4-pin fan headers are backwards compatible with the traditional 3-pin fans. However, fan speed control is available for 4-pin fans only by Thermal Management via the IPMI 2.0 interface. Refer to the table below for pin definitions.

Fan Header Pin Definitions	
Pin#	Definition
1	GND (Black)
2	+12V (Red)
3	Tachometer
4	PWM Control

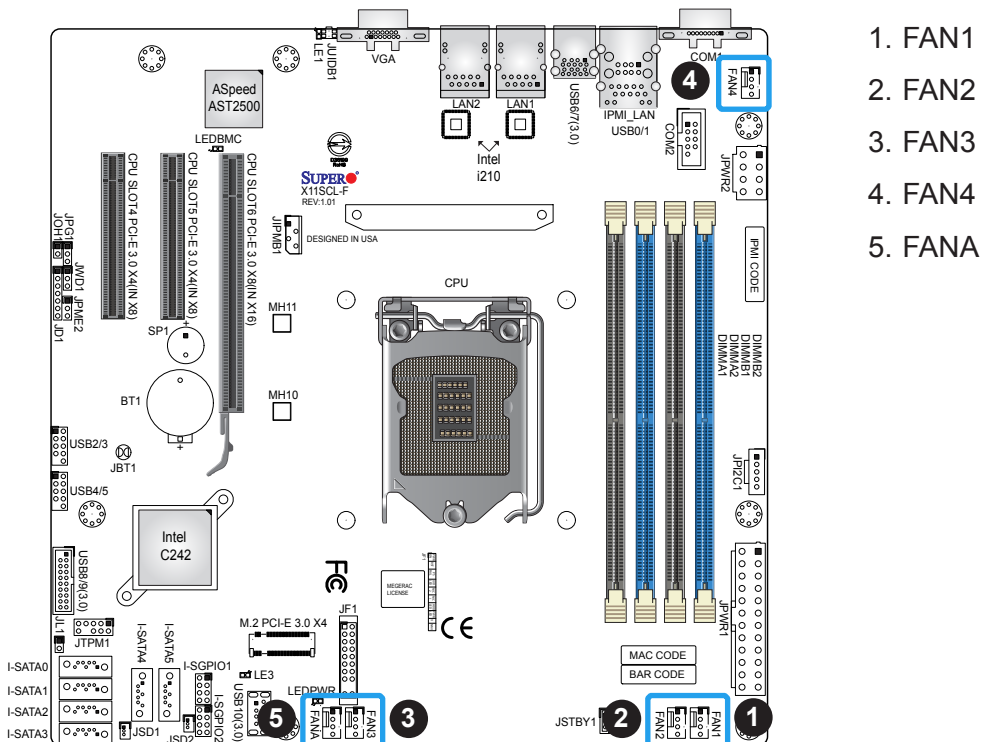

TPM/Port 80 Header

A Trusted Platform Module (TPM)/Port 80 header is located at JTPM1 to provide TPM support and Port 80 connection. Use this header to enhance system performance and data security. Refer to the table below for pin definitions. Please go to the following link for more information on the TPM: <http://www.supermicro.com/manuals/other/TPM.pdf>.

Trusted Platform Module Header Pin Definitions			
Pin#	Definition	Pin#	Definition
1	+3.3V	2	SPI_CS#
3	RESET#	4	SPI_MISO
5	SPI_CLK	6	GND
7	SPI_MOSI	8	NC
9	+3.3V Stdbby	10	SPI_IRQ#

M.2 Slot

The X11SCL-F motherboard has one M.2 slot. M.2 was formerly known as Next Generation Form Factor (NGFF) and serves to replace mini PCI-E. M.2 allows for a variety of card sizes, increased functionality, and spatial efficiency. The M.2 socket on the motherboard supports SSD cards in a 2280 / 22110 form factor.

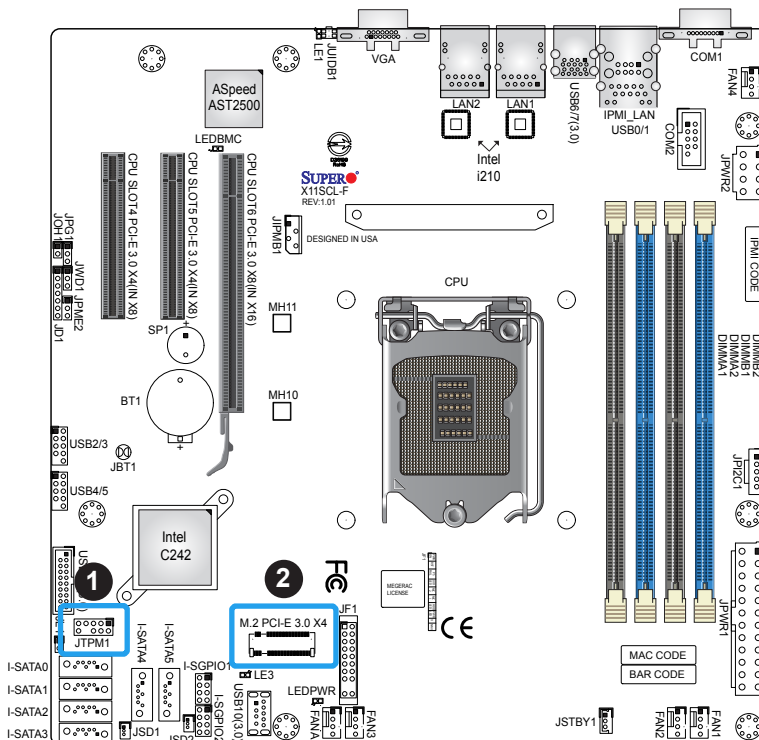

1. TPM Header
2. M.2 Slot

Standby Power

The Standby Power header is located at JSTBY1 on the motherboard. You must have a card with a Standby Power connector and a cable to use this feature. Refer to the table below for pin definitions.

Standby Power Pin Definitions	
Pin#	Definition
1	+5V Standby
2	GND
3	NC

Overheat/Fan Fail LED Header

The JOH1 header is used to connect an LED indicator to provide warnings of chassis overheating and fan failure. This LED will blink when a fan failure occurs. Refer to the tables below for pin definitions.

Overheat LED Header Status	
State	Definition
Solid	Overheat
Blinking	Fan Fail

Overheat LED Pin Definitions	
Pin#	Signal
1	Pull high to +3.3V power through 330-ohm resistor
2	OH Active

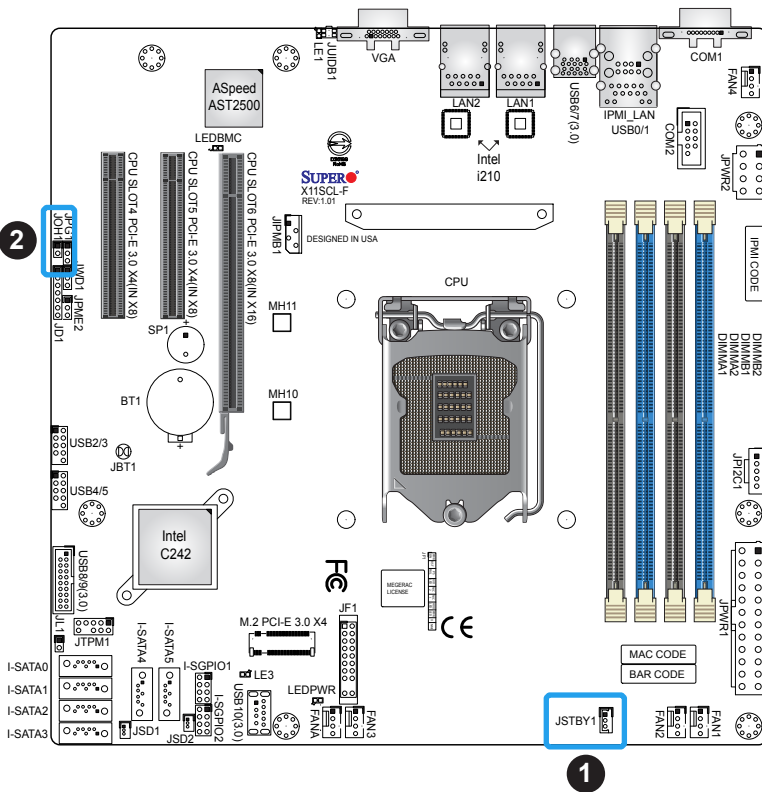

1. Standby Power Header
2. Overheat/Fan Fail LED Header

Chassis Intrusion

A Chassis Intrusion header is located at JL1 on the motherboard. Attach the appropriate cable from the chassis to inform you of a chassis intrusion when the chassis is opened. Refer to the table below for pin definitions.

Chassis Intrusion Pin Definitions	
Pin#	Definition
1	Intrusion Input
2	GND

SGPIO Headers

There are two Serial Link General Purpose Input/Output (I-SGPIO1, I-SGPIO2) headers located on the motherboard. The SGPIO headers are used to communicate with the enclosure management chip on the back panel.

I-SGPIO 1/2	
I-SGPIO1	I-SATA 3.0 Ports 0-3
I-SGPIO2	I-SATA 3.0 Ports 4-5

SGPIO Header Pin Definitions			
Pin#	Definition	Pin#	Definition
1	NC	2	NC
3	GND	4	DATA Out
5	Load	6	GND
7	Clock	8	NC

NC = No Connection

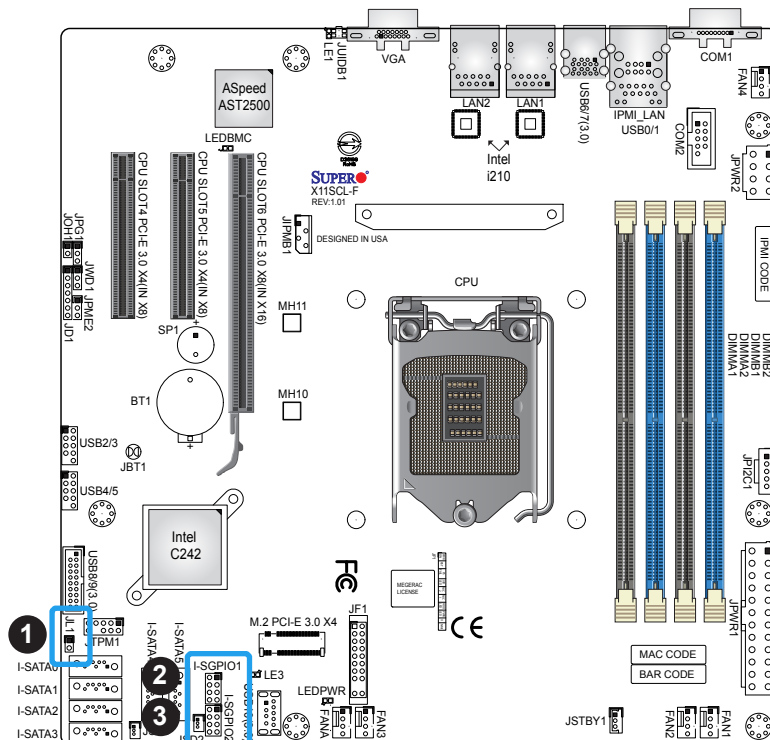

1. Chassis Intrusion Header
2. I-SGPIO1 Header
3. I-SGPIO2 Header

4-pin BMC External I²C Header

A System Management Bus header for IPMI 2.0 is located at JIPMB1. Connect the appropriate cable here to use the IPMB I²C connection on your system. Refer to the table below for pin definitions.

External I ² C Header Pin Definitions	
Pin#	Definition
1	Data
2	GND
3	Clock
4	NC

Power SMB (I²C) Header

The Power System Management Bus (I²C) connector (JPI²C1) monitors the power supply, fan, and system temperatures. Refer to the table below for pin definitions.

Power SMBus Header Pin Definitions	
Pin#	Definition
1	Clock
2	Data
3	PMBUS_Alert
4	GND
5	+3.3V

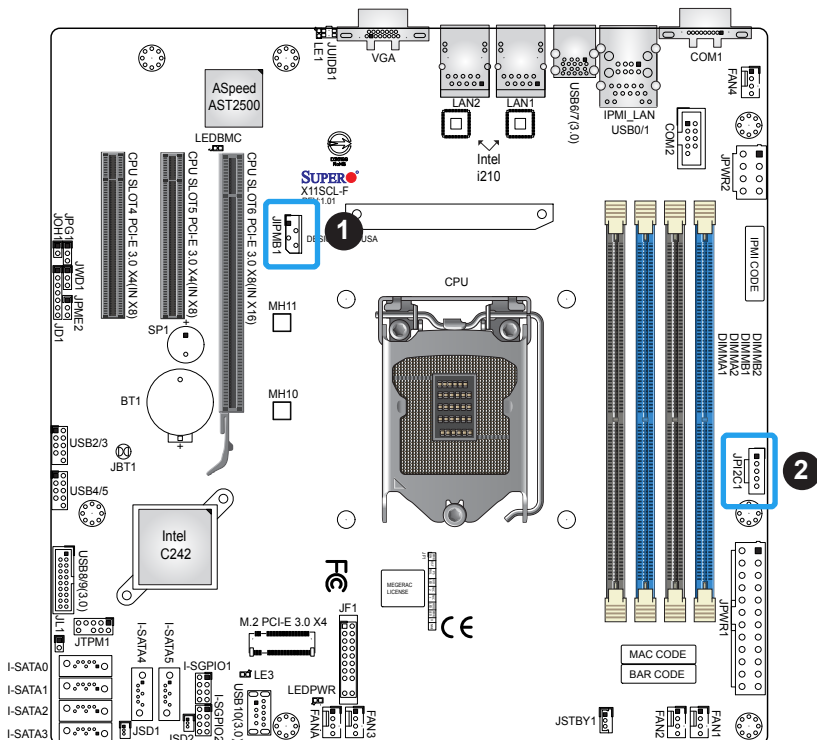

1. BMC External I²C Header
2. Power SMB Header

Onboard Buzzer

The Onboard Buzzer (SP1) is used to provide audible indicators for various beep codes. By default, pins 6-7 of JD1 are closed with a cap, which enables the use of this buzzer. Refer to the table below for pin definitions.

Onboard Buzzer Pin Definitions		
Pin#	Definition	
1	Pos (+)	VCC
2	Neg (-)	Beep In

Power LED Indicator/Speaker Header

Pins 1-3 of JD1 are used for power LED indication. By default, pins 6-7 are closed with a cap to enable the onboard buzzer at SP1. To use an extra speaker instead, connect the speaker connector to pins 4-7. Refer to the tables below for pin definitions.

PWR LED Connector Pin Definitions	
Pin#	Signal
1	VCC
2	FP_PWR_LED
3	FP_PWR_LED

Speaker/Onboard Buzzer Header Pin Definitions	
Pin#	Signal
4	P5V
5	Key
6	R_SPKPIN_N
7	R_SPKPIN

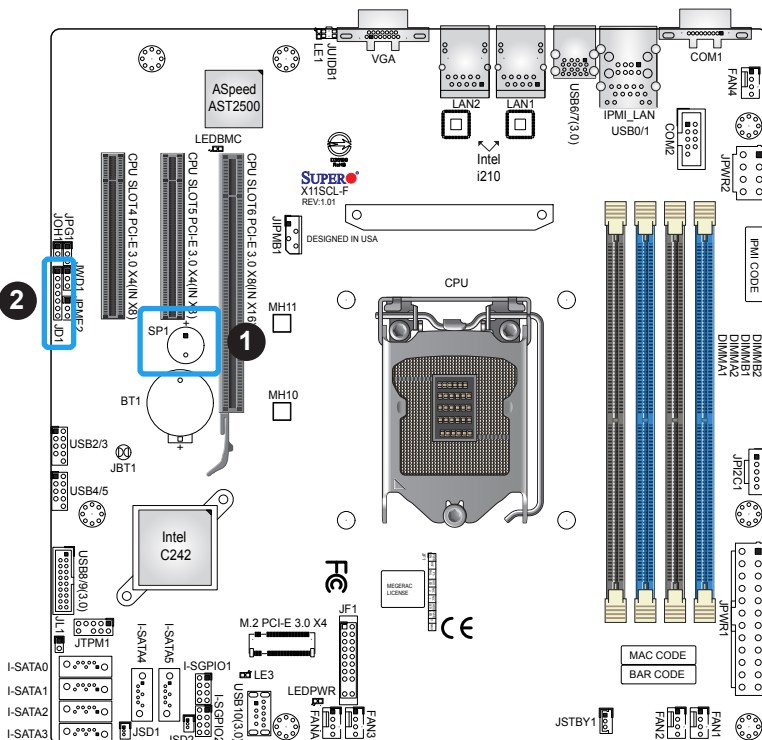

1. Onboard Buzzer
2. Power LED Indicator/Speaker Header

SATA Ports

The X11SCL-F has six SATA 3.0 ports (I-SATA0 ~ I-SATA5) supported by the Intel C242 chipset. These SATA ports support RAID 0, 1, 5, and 10. SATA ports provide serial-link signal connections, which are faster than the connections of Parallel ATA.

Note: Supermicro SuperDOMs are yellow SATADOM connectors with power pins built in and do not require separate external power cables. These connectors are backwards compatible with non-Supermicro SATADOMs that require an external power supply.

Disk-On-Module Power Connector

Two power connectors for SATA DOM (Disk-On-Module) devices are located at JSD1 and JSD2. Connect appropriate cables here to provide power support for your Serial Link DOM devices.

DOM Power Pin Definitions	
Pin#	Definition
1	5V
2	GND
3	GND

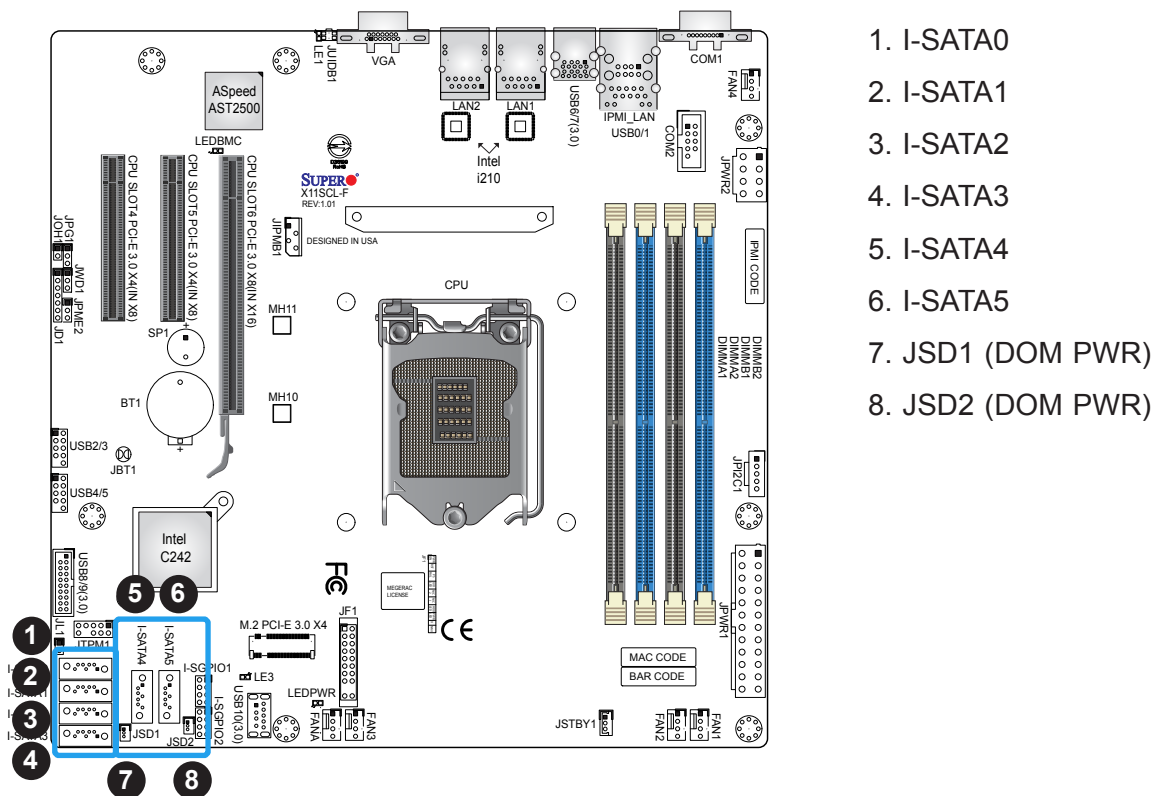

1. I-SATA0
2. I-SATA1
3. I-SATA2
4. I-SATA3
5. I-SATA4
6. I-SATA5
7. JSD1 (DOM PWR)
8. JSD2 (DOM PWR)

2.8 Jumper Settings

How Jumpers Work

To modify the operation of the motherboard, jumpers can be used to choose between optional settings. Jumpers create shorts between two pins to change the function of the connector. Pin 1 is identified with a square solder pad on the printed circuit board. See the diagram below for an example of jumping pins 1 and 2. Refer to the motherboard layout page for jumper locations.

 **Note:** On two-pin jumpers, "Closed" means the jumper is on and "Open" means the jumper is off the pins.

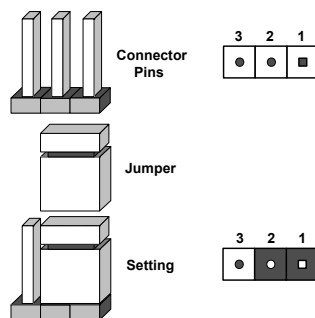

CMOS Clear

JBT1 is used to clear CMOS, which will also clear any passwords. Instead of pins, this jumper consists of contact pads to prevent accidentally clearing the contents of CMOS.

To Clear CMOS

1. First power down the system and unplug the power cord(s).
2. Remove the cover of the chassis to access the motherboard.
3. Remove the onboard battery from the motherboard.
4. Short the CMOS pads with a metal object such as a small screwdriver for at least four seconds.
5. Remove the screwdriver (or shorting device).
6. Replace the cover, reconnect the power cord(s), and power on the system.

 **Note:** Clearing CMOS will also clear all passwords.

Do not use the PW_ON connector to clear CMOS.



JBT1 contact pads

ME Manufacturing Mode

Close pins 2-3 of jumper JPME2 to bypass SPI flash security and force the system to operate in the manufacturing mode, which will allow the user to flash the system firmware from a host server for system setting modifications. Refer to the table below for jumper settings. The default setting is Normal.

Manufacturing Mode Jumper Settings	
Jumper Setting	Definition
Pins 1-2	Normal
Pins 2-3	Manufacturing Mode

Watchdog Timer

Watchdog (JWD1) is a system monitor that can reboot the system when a software application hangs. Close pins 1-2 to reset the system if an application hangs. Close pins 2-3 to generate a non-maskable interrupt (NMI) signal for the application that hangs. Refer to the table below for jumper settings. The Watchdog must also be enabled in the BIOS.

Watchdog Jumper Settings	
Jumper Setting	Definition
Pins 1-2	Reset
Pins 2-3	NMI
Open	Disabled

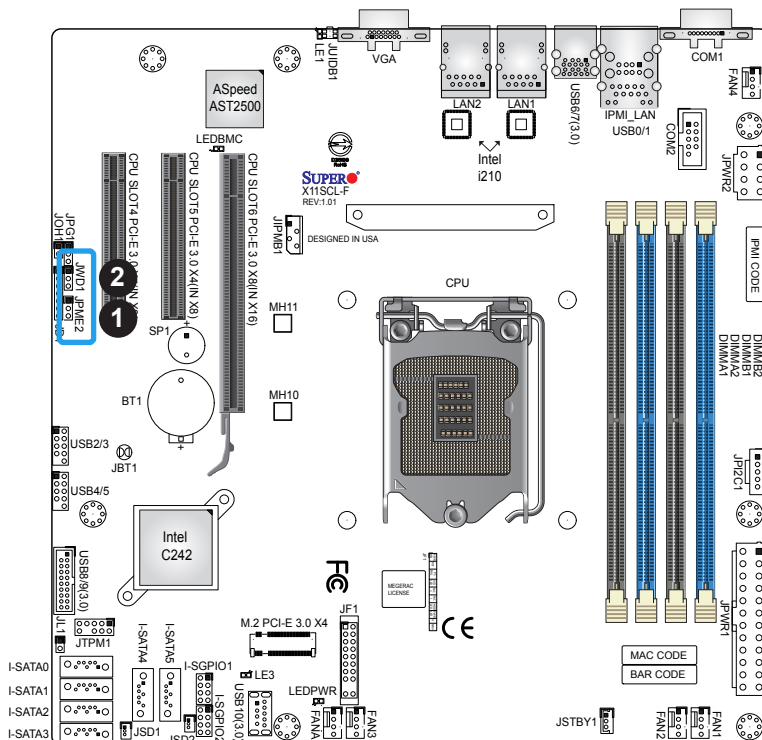

1. ME Manufacturing Mode
2. Watchdog Timer

VGA Enable

Jumper JPG1 allows the user to enable the onboard VGA connector. The default setting is pins 1-2 to enable the connection. Refer to the table below for jumper settings.

VGA Enable/Disable Jumper Settings	
Jumper Setting	Definition
Pins 1-2	Enabled
Pins 2-3	Disabled

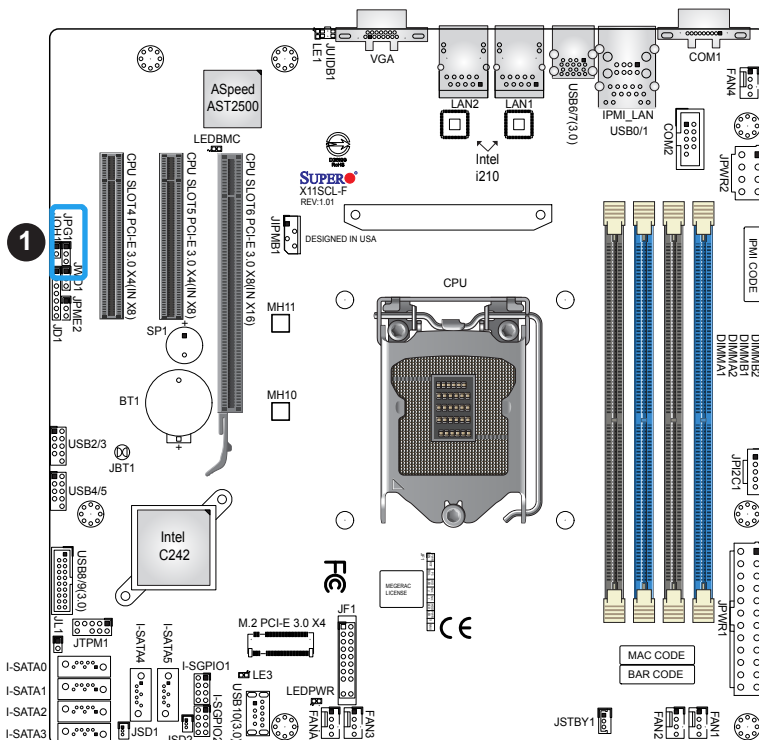

1. VGA Enable

2.9 LED Indicators

LAN LEDs

Two LAN ports (LAN 1, LAN 2) are located on the back I/O panel of the motherboard. Each Ethernet LAN port has two LEDs. The green LED indicates activity, while the other Link LED may be green, amber, or off to indicate the speed of the connection. Refer to the tables below for more information.

LAN Activity LED (Right) LED State		
Color	Status	Definition
Green	Flashing	Active

LAN Link LED (Left) LED State	
LED Color	Definition
Off	No Connection/10 Mbps
Amber	1 Gbps
Green	100 Mbps

Unit ID LED

A rear UID LED indicator (LE1) is located near the UID switch on the back I/O panel. This UID indicator provides easy identification of a system unit that may need service.

UID LED LED Indicator	
LED Color	Definition
Blue: On	Unit Identified

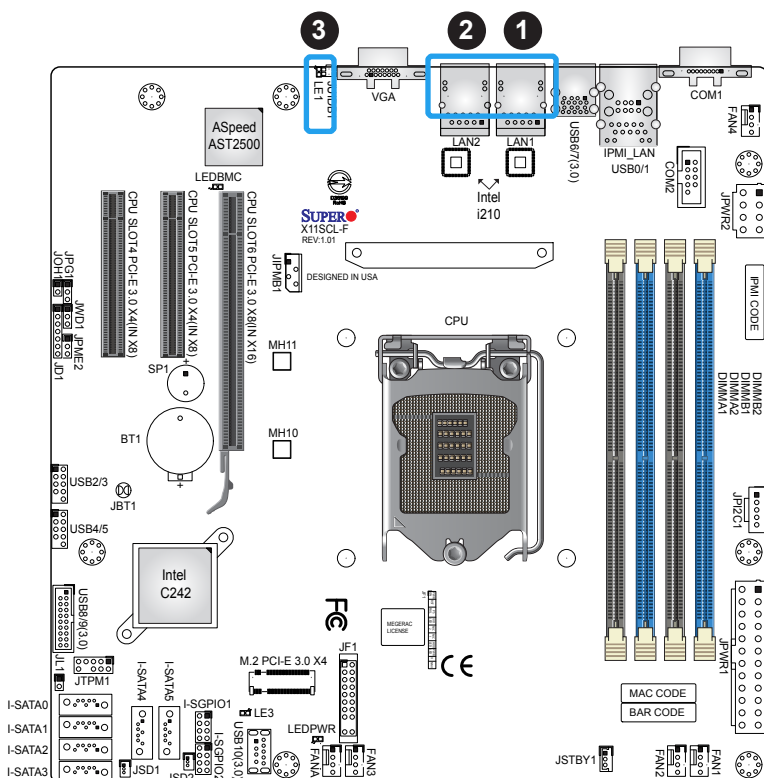

1. LAN1 LED
2. LAN2 LED
3. UID LED

IPMI LAN LEDs

In addition to LAN1 and LAN2, an IPMI LAN is also located on the back I/O panel. The amber LED on the right indicates activity, while the green LED on the left indicates the speed of the connection. Refer to the table below for more information.

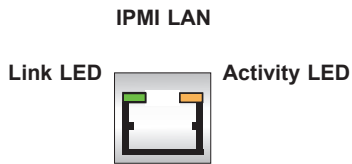

IPMI LAN LEDs		
	Color/State	Definition
Link (left)	Green: Solid Amber: Solid	100 Mbps 1Gbps
Activity (Right)	Amber: Blinking	Active

BMC Heartbeat LED

A BMC Heartbeat LED is located at LEDBMC on the motherboard. When LEDBMC is blinking, the BMC is functioning normally. Refer to the table below for more information.

BMC Heartbeat LED Indicator	
LED Color	Definition
Green: Blinking	BMC Normal

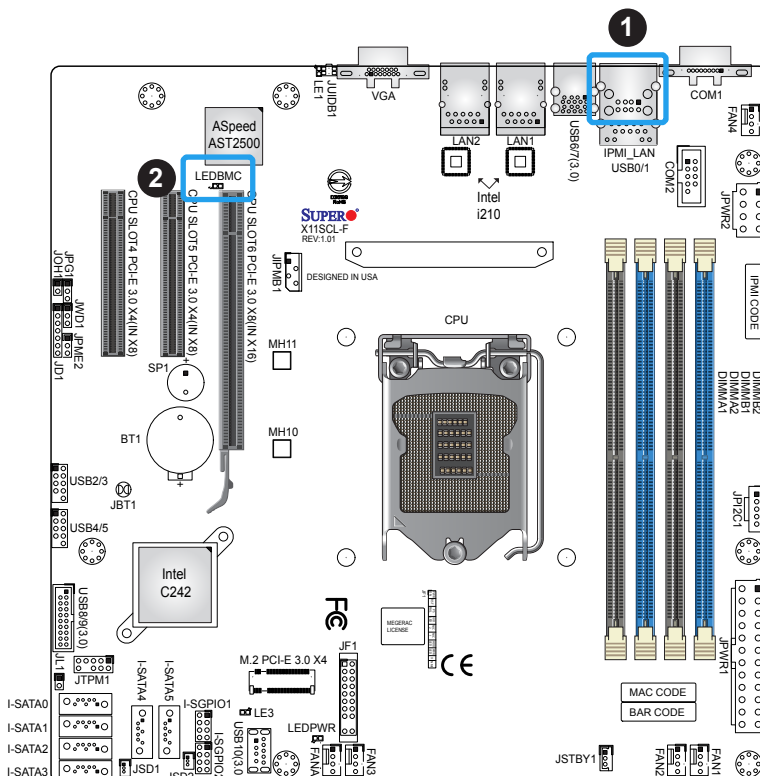

1. IPMI LAN LED
2. BMC Heartbeat LED

Onboard Power LED

The Onboard Power LED is located at LEDPWR on the motherboard. When this LED is on, the system is on. Be sure to turn off the system and unplug the power cord before removing or installing components. Refer to the table below for more information.

Onboard Power LED Indicator	
LED Color	Definition
Off	System Off (power cable not connected)
Green	System On

M.2 LED

One M.2 LED is located at LE3 on the motherboard. When LE3 is blinking, M.2 functions normally. Refer to the table below for more information.

M.2 LED State	
LED Color	Definition
Green: Blinking	Device Working

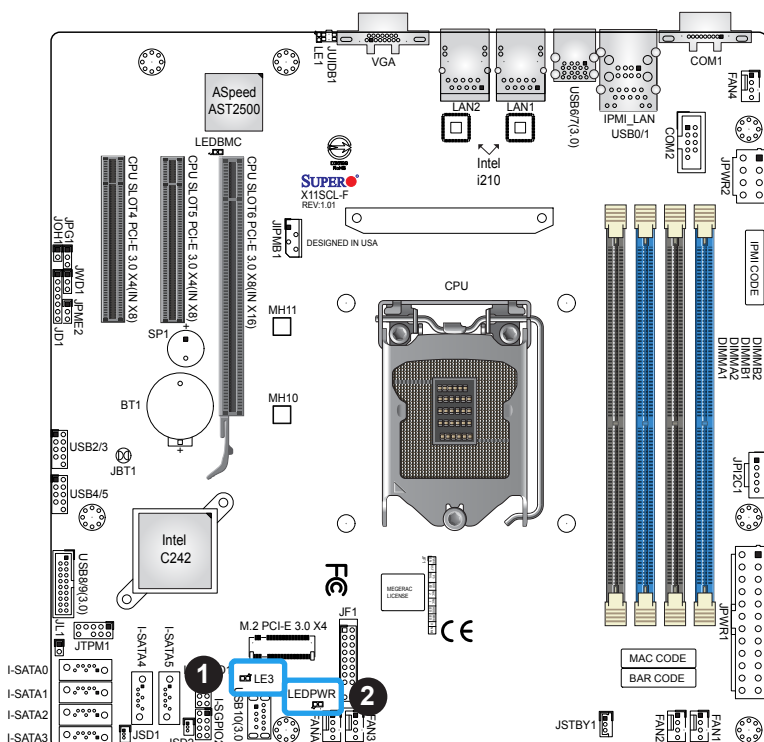

1. Onboard Power LED
2. M.2 LED

Chapter 3

Troubleshooting

3.1 Troubleshooting Procedures

Use the following procedures to troubleshoot your system. If you have followed all of the procedures below and still need assistance, refer to the "Technical Support Procedures" and/or "Returning Merchandise for Service" section(s) in this chapter. Always disconnect the AC power cord before adding, changing or installing any non hot-swap hardware components.

Before Power On

1. Check that the power LED on the motherboard is on.
2. Make sure that the power connector is connected to your power supply.
3. Make sure that no short circuits exist between the motherboard and chassis.
4. Disconnect all cables from the motherboard, including those for the keyboard and mouse.
5. Remove all add-on cards.
6. Install the CPU (making sure it is fully seated) and connect the front panel connectors to the motherboard.
7. Use the correct type of onboard CMOS battery recommended by the manufacturer. To avoid possible explosion, do not install the CMOS battery upside down.

No Power

1. Make sure that there are no short circuits between the motherboard and the chassis.
2. Verify that the ATX power connectors are properly connected.
3. Check that the 115V/230V switch, if available, on the power supply is properly set.
4. Turn the power switch on and off to test the system.
5. The battery on your motherboard may be old. Verify that it still supplies ~3VDC. If it does not, replace it with a new one.

No Video

1. If the power is on, but there is no video, remove all add-on cards and cables.
2. Use the speaker to determine if any beep codes are detected. Refer to Appendix A for details on beep codes.
3. Remove all memory modules and turn on the system. If the alarm is on, check the specs of the memory modules, reset the memory, or try a different one.

System Boot Failure

If the system does not display POST (Power-On-Self-Test) or does not respond after the power is turned on, check the following:

1. Check for any error beeps from the motherboard speaker.
 - If there is no error beep, try to turn on the system without DIMM modules installed. If there is still no error beep, replace the motherboard.
 - If there are error beeps, clear the CMOS settings by unplugging the power cord and contacting both pads on the CMOS Clear jumper (JBT1). Refer to Chapter 2.
2. Remove all components from the motherboard, especially the DIMM modules. Make sure that system power is on and that memory error beeps are activated.
3. Turn on the system with only one DIMM module installed. If the system boots, check for bad DIMM modules or slots by following the Memory Errors Troubleshooting procedure in this chapter.

Memory Errors

When a no-memory beep code is issued by the system, check the following:

1. Make sure that the memory modules are compatible with the system and are properly installed. See Chapter 2 for installation instructions. (For memory compatibility, refer to the "Tested Memory List" link on the motherboard's product page to see a list of supported memory.)
2. Check if different speeds of DIMMs have been installed. It is strongly recommended that you use the same RAM type and speed for all DIMMs in the system.
3. Make sure that you are using the correct type of ECC DDR4 modules recommended by the manufacturer.
4. Check for bad DIMM modules or slots by swapping a single module among all memory slots and observing the results.

Losing the System's Setup Configuration

1. Make sure that you are using a high-quality power supply. A poor-quality power supply may cause the system to lose the CMOS setup information. Refer to Chapter 2 for details on recommended power supplies.
2. The battery on your motherboard may be old. Verify that it still supplies ~3VDC. If it does not, replace it with a new one.
3. If the above steps do not fix the setup configuration problem, contact your vendor for repairs.

When the System Becomes Unstable

A. If the system becomes unstable during or after OS installation, check the following:

1. CPU/BIOS support: Make sure that your CPU is supported and that you have the latest BIOS installed in your system.
2. Memory support: Make sure that the memory modules are supported by testing the modules using memtest86 or a similar utility.



Note: Click on the "Tested Memory List" link on the motherboard's product page to see a list of supported memory.

3. HDD support: Make sure that all hard disk drives (HDDs) work properly. Replace the bad HDDs with good ones.
4. System cooling: Check the system cooling to make sure that all heatsink fans, CPU/system fans, etc., work properly. Check the hardware monitoring settings in the IPMI to make sure that the CPU and system temperatures are within the normal range. Also check that the front panel Overheat LED is not on.
5. Adequate power supply: Make sure that the power supply provides adequate power to the system and all power connectors are connected. Please refer to our website for more information on the minimum power requirements.
6. Proper software support: Make sure that the correct drivers are used.

B. If the system becomes unstable before or during OS installation, check the following:

1. Source of installation: Make sure that the devices used for installation are working properly, including boot devices such as CD.
2. Cable connection: Check to make sure that all cables are connected and working properly.

3. Using the minimum configuration for troubleshooting: Remove all unnecessary components (starting with add-on cards), and use the minimum configuration (but with a CPU and memory module installed) to identify the trouble areas. Refer to the steps listed in Section A for proper troubleshooting procedures.
4. Identifying bad components by isolating them: If necessary, remove a component in question from the chassis, and test it in isolation to make sure that it works properly. Replace a bad component with a good one.
5. Check and change one component at a time instead of changing several items at the same time. This will help isolate and identify the problem.
6. To find out if a component is good, swap this component with a new one to see if the system will work properly. If so, then the old component is bad. You can also install the component in question in another system. If the new system works, the component is good and the old system has problems.

3.2 Technical Support Procedures

Before contacting Technical Support, please follow the steps below. Note that as a motherboard manufacturer, Supermicro sells motherboards through various channels, so it is best to first check with your distributor or reseller for troubleshooting services. They should know of any possible problems with the specific system configuration that was sold to you.

1. Please review the "Troubleshooting Procedures" and "Frequently Asked Questions" (FAQs) sections in this chapter, or see the FAQs on our website before contacting Technical Support: <http://www.supermicro.com/FAQ/index.php>

2. BIOS upgrades can be downloaded from our website.



Note: Not all BIOS can be flashed depending on the modifications to the boot block code.

3. If you still cannot resolve the problem, include the following information when contacting us for technical support:

- Motherboard model and PCB revision number
- BIOS release date/version (this can be seen on the initial display when your system first boots up)
- System configuration

An example of a Technical Support form is posted on our website: <http://www.supermicro.com/RmaForm/>.

- Distributors: For immediate assistance, please have your account number ready when contacting our Technical Support department by e-mail: support@supermicro.com

3.3 Frequently Asked Questions

Question: What type of memory does my motherboard support?

Answer: The motherboard supports UDIMM DDR4 ECC memory. To enhance memory performance, do not mix memory modules of different speeds and sizes. See Section 2.4 for details on installing memory.

Question: How do I update my BIOS under UEFI Shell?

Answer: It is recommended that you do not upgrade your BIOS if you are not experiencing any problems with your system. Updated BIOS files are located on our website at http://www.supermicro.com/ResourceApps/BIOS_IPMI_Intel.html. Please check our BIOS warning message and the information on how to update your BIOS on our website. Select your motherboard model and download the BIOS file to your computer. Also, check the current BIOS revision to make sure that it is newer than your BIOS before downloading. To update your BIOS under the UEFI shell, please unzip the BIOS file onto a USB device formatted with the FAT/FAT32 file system. When the UEFI shell prompt appears, type `fs#` to change the device directory path. Go to the directory that contains the BIOS package you extracted earlier. Enter `flash.nsh BIOSname#.###` at the prompt to start the BIOS update process. Reboot the system when you see the message that the BIOS update has completed. Refer to Appendix D UEFI BIOS Recovery and/or readme file for more information.

Warning: Do not shut down or reset the system while updating the BIOS to prevent possible system boot failure.



Note: The SPI BIOS chip used on this motherboard cannot be removed. Send your motherboard back to our RMA department at Supermicro for repair. For BIOS Recovery instructions, please refer to the AMI BIOS Recovery Instructions at <http://www.supermicro.com/support/manuals>.

Question: Why can't I turn off the power using the momentary power on/off switch?

Answer: The instant power off function is controlled in the BIOS by the Power Button Mode setting. When the On/Off feature is enabled, the motherboard will have instant off capabilities as long as the BIOS has control of the system. When the Standby or Suspend feature is enabled or when the BIOS is not in control such as during memory count (the first screen that appears when the system is turned on), the momentary on/off switch must be held for more than four seconds to shut down the system. This feature is required to implement the ACPI features on the motherboard.

3.4 Battery Removal and Installation

Battery Removal

To remove the onboard battery, follow the steps below:

1. Power off your system and unplug your power cable.
2. Using a tool such as a pen or a small screwdriver, push the battery lock outwards to unlock it. Once unlocked, the battery will pop out from the holder.
3. Remove the battery.

Proper Battery Disposal

Please handle used batteries carefully. Do not damage the battery in any way. A damaged battery may release hazardous materials into the environment. Do not discard a used battery in the garbage or a public landfill. Please comply with the regulations set up by your local hazardous waste management agency to properly dispose of your used battery.

Battery Installation

1. To install an onboard battery, follow steps 1 and 2 above, then continue below:
2. Identify the battery's polarity. The positive (+) side should be facing up.
3. Insert the battery into the battery holder and push it down until you hear a click to ensure that the battery is securely locked.



Note: When replacing a battery, be sure to only replace it with the same type.

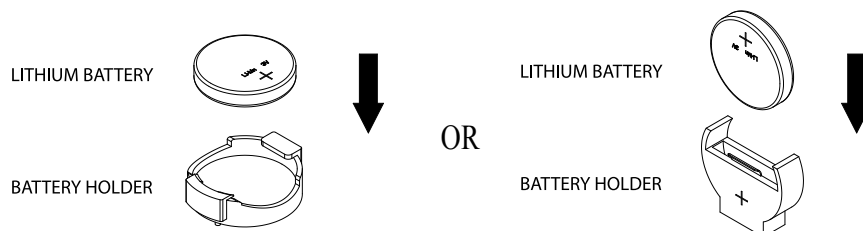

3.5 Returning Merchandise for Service

A receipt or copy of your invoice marked with the date of purchase is required before any warranty service will be rendered. You can obtain service by calling your vendor for a Returned Merchandise Authorization (RMA) number. When returning to the manufacturer, the RMA number should be prominently displayed on the outside of the shipping carton and mailed prepaid or hand-carried. Shipping and handling charges will be applied for all orders that must be mailed when service is complete.

For faster service, RMA authorizations may be requested online: <http://www.supermicro.com/RmaForm/>

This warranty only covers normal consumer use and does not cover damages incurred in shipping or from failure due to the alteration, misuse, abuse or improper maintenance of products.

During the warranty period, contact your distributor first for any product problems.

Chapter 4

BIOS

4.1 Introduction

This chapter describes the AMIBIOS™ Setup utility for the motherboard. The BIOS is stored on a chip and can be easily upgraded using a flash program.



Note: Due to periodic changes to the BIOS, some settings may have been added or deleted and might not yet be recorded in this manual. Please refer to the Manual Download area of our website for any changes to the BIOS that may not be reflected in this manual.

Starting the Setup Utility

To enter the BIOS Setup Utility, hit the <Delete> key while the system is booting-up. (In most cases, the <Delete> key is used to invoke the BIOS setup screen. There are a few cases when other keys are used, such as <F1>, <F2>, etc.) Each main BIOS menu option is described in this manual.

The Main BIOS screen has two main frames. The left frame displays all the options that can be configured. “Grayed-out” options cannot be configured. The right frame displays the key legend. Above the key legend is an area reserved for a text message. When an option is selected in the left frame, it is highlighted in white. Often a text message will accompany it. (Note that the BIOS has default text messages built in. We retain the option to include, omit, or change any of these text messages.) Settings printed in **Bold** are the default values.

A " ►" indicates a submenu. Highlighting such a feature and pressing the <Enter> key will open the list of settings within that submenu.

The BIOS setup utility uses a key-based navigation system called hot keys. Most of these hot keys (<F1>, <F2>, <F3>, <Enter>, <ESC>, <Arrow> keys, etc.) can be used at any time during the setup navigation process.

4.2 Main Setup

When you first enter the AMI BIOS setup utility, you will enter the Main setup screen. You can always return to the Main setup screen by selecting the Main tab. The Main BIOS setup screen is shown below. The following features will be displayed:

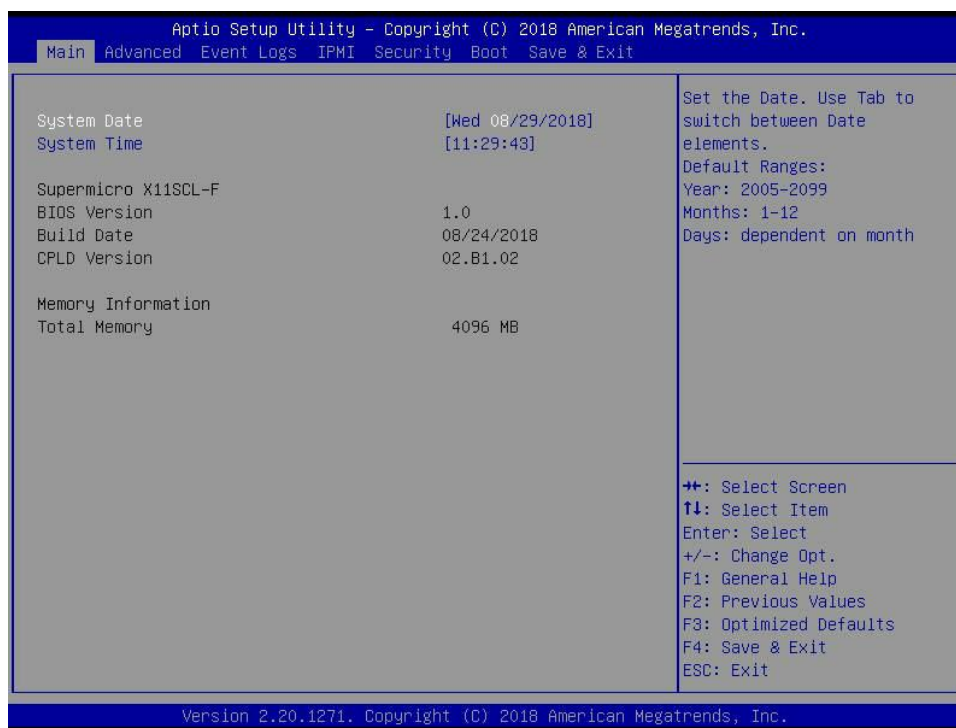

System Date/System Time

Use this feature to change the system date and time. Highlight *System Date* or *System Time* using the arrow keys. Enter new values using the keyboard. Press the <Tab> key or the arrow keys to move between fields. The date must be entered in MM/DD/YYYY format. The time is entered in HH:MM:SS format.

 **Note:** The time is in the 24-hour format. For example, 5:30 P.M. appears as 17:30:00. The date's default value is the BIOS build date after RTC reset.

Supermicro X11SCL-F

BIOS Version

This item displays the version of the BIOS ROM used in the system.

Build Date

This item displays the date when the version of the BIOS ROM used in the system was built.

CPLD Version

This item displays the Complex Programmable Logic Device version.

Memory Information

Total Memory

This item displays the total size of memory available in the system.

4.3 Advanced Setup Configurations

Use the arrow keys to select the Advanced menu and press <Enter> to access the submenu features:

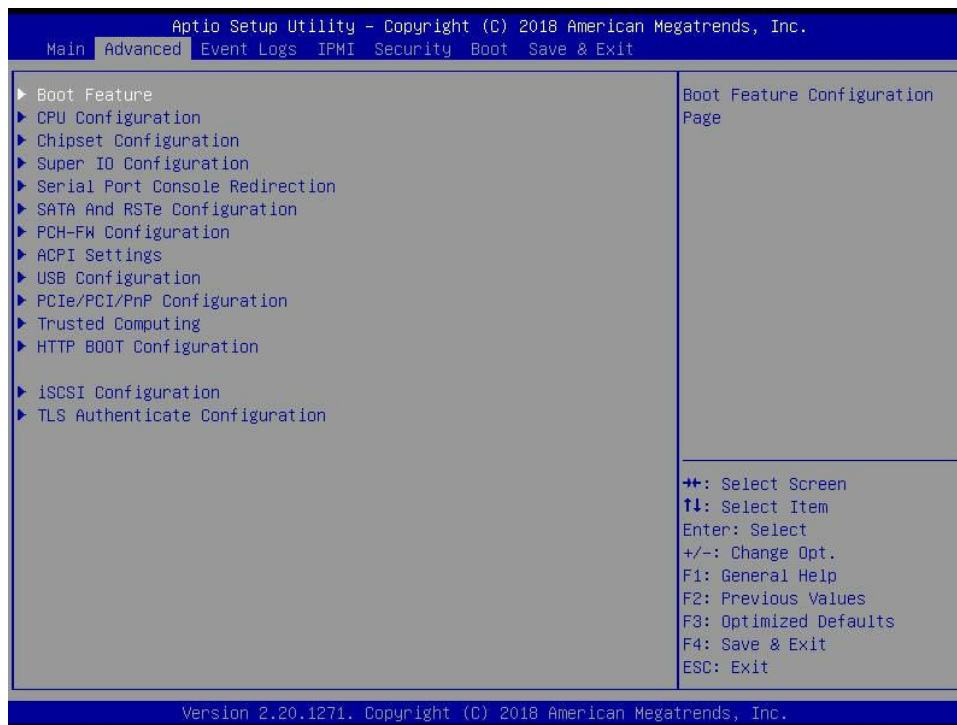

Warning: Take caution when changing the Advanced settings. An incorrect value, a very high DRAM frequency, or an incorrect DRAM timing setting may make the system unstable. When this occurs, revert to default manufacturer settings.

► Boot Feature

Fast Boot

Enable this feature to reduce the time the computer takes to boot up. The computer will boot with a minimal set of required devices. This feature does not have an effect on BBS boot options in the Boot tab. The options are **Disabled** and Enabled.

Quiet Boot

Use this feature to select the screen display between the POST messages and the OEM logo upon bootup. Select Disabled to display the POST messages. Select Enabled to display the OEM logo instead of the normal POST messages. The options are Disabled and **Enabled**.

Startup NumLock State

Use this feature to set the Power-on state for the <Numlock> key. The options are **On** and Off.

Option ROM Messages

Use this feature to set the display mode for the Option ROM. Select Keep Current to display the current AddOn ROM setting. Select Force BIOS to use the Option ROM display set by the system BIOS. The options are **Force BIOS** and Keep Current.

Wait For "F1" If Error

Use this feature to force the system to wait until the "F1" key is pressed if an error occurs. The options are Disabled and **Enabled**.

Re-try Boot

If this feature is enabled, the BIOS will automatically reboot the system from a specified boot device after its initial boot failure. The options are **Disabled**, Legacy Boot, and EFI Boot.

Watch Dog Function

If enabled, the Watch Dog Timer will allow the system to reset or generate NMI based on jumper settings when it is expired for more than five minutes. The options are **Disabled** and Enabled.

AC Loss Policy Depend On

Use this feature to set the power state after a power outage. Select Stay Off for the system power to remain off after a power loss. Select Power On for the system power to be turned on after a power loss. Select Last State to allow the system to resume its last power state before a power loss. The options are Stay Off, Power On, and **Last State**.

Power Button Function

This feature controls how the system shuts down when the power button is pressed. Select 4 Seconds Override for the user to power off the system after pressing and holding the power button for four seconds or longer. Select Instant Off to instantly power off the system as soon as the user presses the power button. The options are **Instant Off** and 4 Seconds Override.

DeepSx Power Policies

Use this feature to configure the Advanced Configuration and Power Interface (ACPI) settings for the system. Enable S4-S5 to power off the whole system except the power supply unit (PSU) and keep the power button "alive" so that the user can "wake up" the system by using a USB keyboard or mouse. The options are **Disabled** and Enabled in S4-S5.

► CPU Configuration

The following CPU information will display:

- Type
- CPU Signature
- Microcode Revision
- CPU Speed
- L1 Data Cache
- L1 Instruction Cache
- L2 Cache
- L3 Cache
- L4 Cache
- VMX
- SMX/TXT

CPU Flex Ratio Override

Select Enabled to activate CPU Flex Ratio programming. The flex ratio should be under the CPU's max ratio. The options are **Disabled** and Enabled.

****If the feature above is set to Enabled, "CPU Flex Ratio Settings" will become available for configuration:***

CPU Flex Ratio Settings

When CPU Flex Ratio Override is enabled, this feature sets the value for the CPU Flex Ratio. This value must be between the maximum efficiency ratio and maximum non-turbo ratio. The default value is dependent on the CPU.

Hardware Prefetcher (Available when supported by the CPU)

If set to Enabled, the hardware prefetcher will prefetch streams of data and instructions from the main memory to the L2 cache to improve CPU performance. The options are Disabled and **Enabled**.

Adjacent Cache Line Prefetch (Available when supported by the CPU)

The CPU prefetches the cache line for 64 bytes if this feature is set to Disabled. The CPU prefetches both cache lines for 128 bytes as comprised if this feature is set to Enabled. The options are Disabled and **Enabled**.

Intel (VMX) Virtualization Technology

Use this feature to enable the Vanderpool Technology. This technology allows the system to run several operating systems simultaneously. The options are Disabled and **Enabled**.

Active Processor Cores

This feature determines how many CPU cores will be activated for each CPU. When All is selected, all cores in the CPU will be activated. (Please refer to Intel's website for more information.) The options are **All**, 1, 2, 3, 4, and 5.

Hyper-Threading (Available when supported by the CPU)

Intel Hyper-Threading Technology efficiently uses processor resources by executing multiple threads on each core. It improves processor execution efficiency and enhances the overall performance of the thread software. The options are Disabled and **Enabled**.

BIST

Use this feature to enable the Built-In Self Test (BIST) at system reset or reboot. The options are **Disabled** and Enabled.

AES

Select Enabled to use the Intel Advanced Encryption Standard (AES) to ensure data security. The options are Disabled and **Enabled**.

Boot Performance Mode

This feature allows the user to select the performance state that the BIOS will set before the operating system handoff. The options are Power Saving, **Max Non-Turbo Performance**, and Turbo Performance.

Intel(R) SpeedStep (tm)

Intel SpeedStep Technology allows the system to automatically adjust processor voltage and core frequency to reduce power consumption and heat dissipation. The options are Disabled and **Enabled**.

Intel(R) Speed Shift Technology

Use this feature to enable or disable Intel Speed Shift Technology support. When this feature is enabled, the Collaborative Processor Performance Control (CPPC) version 2 interface will be available to control CPU P-States. The options are **Disabled** and Enabled.

Always Turbo Mode

Use this feature to enable the system to always run in turbo mode. The options are **Disabled** and Enabled.

Turbo Mode

This feature will enable dynamic control of the processor, allowing it to run above stock frequency. The options are Disabled and **Enabled**.

Monitor/Mwait

Select Enabled to enable the Monitor/Mwait instructions. The Monitor instructions monitor a region of memory for writes, while MWait instructions instruct the CPU to stop until the monitored region begins to write. The options are Disabled and **Enabled**.

C-States

C-State architecture, a processor power management platform developed by Intel, can further reduce power consumption from the basic C1 (Halt State) state that blocks clock cycles to the CPU. Select Enabled for CPU C-State support. The options are Disabled and **Enabled**.

Enhanced C-States

Use this feature to enable C1E, which is a power saving feature for the CPU. C1E drops the frequency and voltage of the CPU to reduce power usage when the system is idle. The options are Disabled and **Enabled**.

C-State Auto Demotion

Use this feature to prevent unnecessary excursions into C-States to improve latency. The options are Disabled, C1, C3, and **C1 and C3**.

C-State Un-Demotion

This feature allows the user to enable or disable the un-demotion of C-States. The options are Disabled, C1, C3, and **C1 and C3**.

Package C-State Demotion

Use this feature to enable or disable the Package C-State demotion. The options are **Disabled** and Enabled.

Package C-State Un-Demotion

Use this feature to enable or disable the Package C-State un-demotion. The options are **Disabled** and Enabled.

C-State Pre-Wake

This feature allows the user to enable or disable the C-State Pre-Wake. The options are Disabled and **Enabled**.

Package C-State Limit

Use this feature to set the Package C-State limit. The options are C0/C1, C2, C3, C6, C7, C7S, C8, C9, C10, CPU Default, and **Auto**.

► Chipset Configuration

Warning: Setting the wrong values in the following features may cause the system to malfunction.

► System Agent (SA) Configuration

The following information is displayed:

- SA PCIe Code Version
- VT-d

► Memory Configuration

- Memory RC Version
- Memory Frequency
- Memory Timings (tCL-tRCD-tRP-tRAS)
- DIMMA1 ~ DIMMB2 information

Maximum Memory Frequency

Use this feature to set the maximum memory frequency for onboard memory modules. The options are **Auto**, 1067, 1333, 1400, 1600, 1800, 1867, 2000, 2133, 2200, 2400, 2600, and 2667.

ECC Support

Use this feature to enable Error Checking & Correction (ECC) support for onboard memory modules. The options are Disabled and **Enabled**.

Max TOLUD

This feature sets the maximum TOLUD value, which specifies the “Top of Low Usable DRAM” memory space to be used by internal graphic devices, GTT Stolen Memory, and TSEG, respectively, if these devices are enabled. The options are **Dynamic** and 1 GB ~ 3.5 GB (in 0.25 GB increments).

Memory Scrambler

This feature enables memory scrambler support for memory error correction. The settings are Disabled and **Enabled**.

Fast Boot

Use this feature to enable or disable fast path through the memory reference code (MRC). The options are Disabled and **Enabled**.

REFRESH_2X_MODE

Use this feature to select the memory controller 2x refresh rate mode. The options are **Disabled**, 1- Enabled for WARM or HOT, and 2- Enabled HOT only.

► DMI/OPI Configuration

The following DMI information will display:

- DMI

DMI Link ASPM Control

Use this feature to set the Active State Power Management (ASPM) state on the System Agent (SA) side of the DMI Link. The options are Disabled, L0s, **L1**, and L0sL1

DMI Extended Sync Control

Use this feature to enable or disable the DMI extended synchronization. The options are Enabled and **Disabled**.

DMI De-Emphasis Control

Use this feature to configure the De-emphasis control on DMI. The options are -6 dB and **-3.5 dB**.

► PEG Port Configuration

CPU SLOT6 PCI-E 3.0 x8 (in x16) / CPU SLOT5 PCI-E 3.0 x4 (in x8) / CPU SLOT4 PCI-E 3.0 x4 (in x8)

Enable Root Port

Use this feature to enable or disable the PCI Express Graphics (PEG) device in the port specified by the user. The options are Disabled, Enabled, and **Auto**.

Max Link Speed

Use this feature to configure the link speed of a PCI-E port specified by the user. The options are **Auto**, Gen1, Gen2, and Gen3.

Power Limit Value

Use this feature to set the upper limit on the power supplied by the PCIE slot. Press "+" or "-" on your keyboard to change this value. The default setting is **75**.

Power Limit Scale

Use this feature to select the scale used for the slot power limit value. The options are **1.0x**, 0.1x, 0.01x, and 0.001x.

Physical Slot Number

Use this feature to set the physical slot number attached to this port. Press "+" or "-" on your keyboard to change the setting to a value between 0-8191. The default setting is **1** for CPU SLOT6, **2** for CPU SLOT5, and **3** for CPU SLOT4.

Max Payload Size

Select Auto for the system BIOS to automatically set the maximum payload value for a PCI-E device to enhance system performance. The options are **Auto**, 128, and 256 TLP.

Program PCIe ASPM After OPROM

PCIe ASPM, the Active State Power Management for PCI-Express slots, is a power management protocol used to manage power consumption of serial-link devices installed on PCI-E slots during a prolonged off-peak time. If this feature is set to Enabled, PCI-E ASPM will be programmed after OPROM. If this feature is set to Disabled, the PCI-E ASPM will be programmed before OPROM. The options are **Disabled** and Enabled.

VT-d

Select Enable to use Intel Virtualization Technology for Direct I/O VT-d support by reporting the I/O device assignments to the VMM (Virtual Machine Monitor) through the DMAR ACPI tables. This feature offers fully-protected I/O resource sharing across Intel platforms, providing greater reliability, security, and availability in networking and data-sharing. The options are Disabled and **Enabled**.

GNA Device (B0:D8:F0)

This feature enables the SA GNA device. The options are **Enabled** and Disabled.

X2APIC Opt Out

X2APIC, an extension of the XAPIC architecture, is designed to support 32-bit processor addressability. X2APIC enhances the performance of interrupt delivery. The options are Enabled and **Disabled**.

► PCH-IO Configuration

► PCI Express Configuration

DMI Link ASPM Control

Use this feature to set the Active State Power Management (ASPM) state on the System Agent (SA) side of the DMI Link. The options are Disable, L0s, L1, L0sL1, and **Auto**.

Peer Memory Write Enable

Use this feature to enable or disable peer memory write. The options are **Disabled** or **Enabled**.

Port 61h Bit-4 Emulation

Select Enabled to enable the emulation of Port 61h bit-4 toggling in System Management Mode (SMM). The options are Disabled and **Enabled**.

PCIE PLL SSC

Use this feature to enable PCI-E phase-locked loop (PLL) spread spectrum clocking (SSC). The options are **Enabled** and Disabled.

► Super IO Configuration

The following Super IO information will display:

- Super IO Chip AST2500

► Serial Port 1 Configuration

This submenu allows the user to configure the settings of Serial Port 1.

Serial Port 1

Select Enabled to enable the selected onboard serial port. The options are Disabled and **Enabled**.

Device Settings

This item displays the status of a serial port specified by the user.

Change Settings

This feature specifies the base I/O port address and the Interrupt Request address of a serial port specified by the user. Select Auto to allow the BIOS to automatically assign the base I/O and IRQ address.

The options for Serial Port 1 are **Auto**, (IO=3F8h; IRQ=4), (IO=2F8h; IRQ=4), (IO=3E8h; IRQ=4), and (IO=2E8h; IRQ=4).

► Serial Port 2 Configuration

This submenu allows the user to configure the settings of Serial Port 2.

Serial Port 2

Select Enabled to enable the selected onboard serial port. The options are Disabled and **Enabled**.

Device Settings

This item displays the status of a serial port specified by the user.

Change Settings

This feature specifies the base I/O port address and the Interrupt Request address of a serial port specified by the user. Select Auto to allow the BIOS to automatically assign the base I/O and IRQ address.

The options for Serial Port 2 are **Auto**, (IO=3F8h; IRQ=3), (IO=2F8h; IRQ=3), (IO=3E8h; IRQ=3), and (IO=2E8h; IRQ=3).

Serial Port 2 Attribute

Select SOL to use COM Port 2 as a Serial Over LAN (SOL) port for console redirection. The options are **SOL** and COM.

► Serial Port Console Redirection

COM1 Console Redirection

Select Enabled to enable console redirection support for a serial port specified by the user. The options are **Disabled** and Enabled.

**If the feature above is set to Enabled, the following settings will become available for configuration:*

► COM1 Console Redirection Settings

Use this feature to specify how the host computer will exchange data with the client computer, which is the remote computer used by the user.

COM1 Terminal Type

This feature allows the user to select the target terminal emulation type for Console Redirection. Select VT100 to use the ASCII Character set. Select VT100+ to add color and function key support. Select ANSI to use the Extended ASCII Character Set. Select VT-UTF8 to use UTF8 encoding to map Unicode characters into one or more bytes. The options are VT100, **VT100+**, VT-UTF8, and ANSI.

COM1 Bits Per Second

Use this feature to set the transmission speed for a serial port used in Console Redirection. Make sure that the same speed is used in the host computer and the client computer. A lower transmission speed may be required for long and busy lines. The options are 9600, 19200, 38400, 57600, and **115200** (bits per second).

COM1 Data Bits

Use this feature to set the data transmission size for Console Redirection. The options are 7 Bits and **8 Bits**.

COM1 Parity

A parity bit can be sent along with regular data bits to detect data transmission errors. Select Even if the parity bit is set to 0, and the number of 1's in data bits is even. Select Odd if the parity bit is set to 0, and the number of 1's in data bits is odd. Select None if you do not want to send a parity bit with your data bits in transmission. Select Mark to add a mark as a parity bit to be sent along with the data bits. Select Space to add a Space as a parity bit to be sent with your data bits. The options are **None**, Even, Odd, Mark, and Space.

COM1 Stop Bits

A stop bit indicates the end of a serial data packet. Select 1 Stop Bit for standard serial data communication. Select 2 Stop Bits if slower devices are used. The options are **1** and **2**.

COM1 Flow Control

Use this feature to set the flow control for Console Redirection to prevent data loss caused by buffer overflow. Send a "Stop" signal to stop sending data when the receiving buffer is full. Send a "Start" signal to start sending data when the receiving buffer is empty. The options are **None** and Hardware RTS/CTS.

COM1 VT-UTF8 Combo Key Support

Select Enabled to enable VT-UTF8 Combination Key support for ANSI/VT100 terminals. The options are Disabled and **Enabled**.

COM1 Recorder Mode

Select Enabled to capture the data displayed on a terminal and send it as text messages to a remote server. The options are **Disabled** and Enabled.

COM1 Resolution 100x31

Select Enabled for extended-terminal resolution support. The options are Disabled and **Enabled**.

COM1 Legacy OS Redirection Resolution

Use this feature to select the number of rows and columns used in Console Redirection for legacy OS support. The options are 80x24 and **80x25**.

COM1 Putty KeyPad

This feature selects the settings for Function Keys and KeyPad used for Putty, which is a terminal emulator designed for the Windows OS. The options are **VT100**, LINUX, XTERMR6, SC0, ESCN, and VT400.

COM1 Redirection After POST

Use this feature to enable or disable legacy console redirection after BIOS POST. When set to BootLoader, legacy console redirection is disabled before booting the OS. When set to Always Enable, legacy console redirection remains enabled when booting the OS. The options are **Always Enable** and BootLoader.

SOL Console Redirection

Select Enabled to enable console redirection support for a serial port specified by the user. The options are Disabled and **Enabled**.

****If the feature above is set to Enabled, the following settings will become available for configuration:***

► SOL Console Redirection Settings

Use this feature to specify how the host computer will exchange data with the client computer, which is the remote computer used by the user.

SOL Terminal Type

This feature allows the user to select the target terminal emulation type for Console Redirection. Select VT100 to use the ASCII Character set. Select VT100+ to add color and function key support. Select ANSI to use the Extended ASCII Character Set. Select VT-UTF8 to use UTF8 encoding to map Unicode characters into one or more bytes. The options are VT100, **VT100+**, VT-UTF8, and ANSI.

SOL Bits Per Second

Use this feature to set the transmission speed for a serial port used in Console Redirection. Make sure that the same speed is used in the host computer and the client computer. A lower transmission speed may be required for long and busy lines. The options are 9600, 19200, 38400, 57600, and **115200** (bits per second).

SOL Data Bits

Use this feature to set the data transmission size for Console Redirection. The options are 7 Bits and **8 Bits**.

SOL Parity

A parity bit can be sent along with regular data bits to detect data transmission errors. Select Even if the parity bit is set to 0, and the number of 1's in data bits is even. Select Odd if the parity bit is set to 0, and the number of 1's in data bits is odd. Select None if you do not want to send a parity bit with your data bits in transmission. Select Mark to add a mark as a parity bit to be sent along with the data bits. Select Space to add a Space as a parity bit to be sent with your data bits. The options are **None**, Even, Odd, Mark, and Space.

SOL Stop Bits

A stop bit indicates the end of a serial data packet. Select 1 Stop Bit for standard serial data communication. Select 2 Stop Bits if slower devices are used. The options are **1** and **2**.

SOL Flow Control

Use this feature to set the flow control for Console Redirection to prevent data loss caused by buffer overflow. Send a "Stop" signal to stop sending data when the receiving buffer is full. Send a "Start" signal to start sending data when the receiving buffer is empty. The options are **None** and Hardware RTS/CTS.

SOL VT-UTF8 Combo Key Support

Select Enabled to enable VT-UTF8 Combination Key support for ANSI/VT100 terminals. The options are Disabled and **Enabled**.

SOL Recorder Mode

Select Enabled to capture the data displayed on a terminal and send it as text messages to a remote server. The options are **Disabled** and Enabled.

SOL Resolution 100x31

Select Enabled for extended-terminal resolution support. The options are Disabled and **Enabled**.

SOL Legacy OS Redirection Resolution

Use this feature to select the number of rows and columns used in Console Redirection for legacy OS support. The options are 80x24 and **80x25**.

SOL Putty KeyPad

This feature selects the settings for Function Keys and KeyPad used for Putty, which is a terminal emulator designed for the Windows OS. The options are **VT100**, LINUX, XTERMR6, SC0, ESCN, and VT400.

SOL Redirection After POST

Use this feature to enable or disable legacy console redirection after BIOS POST. When set to BootLoader, legacy console redirection is disabled before booting the OS. When set to Always Enable, legacy console redirection remains enabled when booting the OS. The options are **Always Enable** and BootLoader.

Legacy Console Redirection

► Legacy Console Redirection Settings

Legacy Redirection COM Port

Use this feature to select a COM port to display redirection of Legacy OS and Legacy OPRM messages. The options are **COM1** and SOL.

Legacy OS Redirection Resolution

Use this feature to select the number of rows and columns used in Console Redirection for legacy OS support. The options are 80x24 and **80x25**.

Legacy Redirection After POST

Use this feature to enable or disable legacy console redirection after BIOS POST. When set to BootLoader, legacy console redirection is disabled before booting the OS. When set to Always Enable, legacy console redirection remains enabled when booting the OS. The options are **Always Enable** and BootLoader.

Serial Port for Out-of-Band Management / Windows Emergency Management Services (EMS)

EMS Console Redirection

Select Enabled to enable console redirection support for a serial port specified by the user. The options are **Disabled** and Enabled.

****If the feature above is set to Enabled, the following settings will become available for configuration:***

► EMS Console Redirection Settings

This feature allows the user to specify how the host computer will exchange data with the client computer, which is the remote computer used by the user.

EMS Out-of-Band Mgmt Port

This feature selects a serial port in a client server to be used by the Microsoft Windows Emergency Management Services (EMS) to communicate with a remote host server. The options are **COM1** and SOL.

EMS Terminal Type

Use this feature to select the target terminal emulation type for Console Redirection. Select VT100 to use the ASCII character set. Select VT100+ to add color and function key support. Select ANSI to use the extended ASCII character set. Select VT-UTF8 to use UTF8 encoding to map Unicode characters into one or more bytes. The options are VT100, VT100+, **VT-UTF8**, and ANSI.

EMS Bits Per Second

This feature sets the transmission speed for a serial port used in Console Redirection. Make sure that the same speed is used in the host computer and the client computer. A lower transmission speed may be required for long and busy lines. The options are 9600, 19200, 57600, and **115200** (bits per second).

EMS Flow Control

Use this feature to set the flow control for Console Redirection to prevent data loss caused by buffer overflow. Send a "Stop" signal to stop sending data when the receiving buffer is full. Send a "Start" signal to start sending data when the receiving buffer is empty. The options are **None**, Hardware RTS/CTS, and Software Xon/Xoff.

EMS Data Bits, Parity, Stop Bits

► SATA and RSTe Configuration

When this submenu is selected, the AMI BIOS automatically detects the presence of the SATA devices that are supported by the Intel PCH chip and displays the following features:

SATA Controller(s)

This feature enables or disables the onboard SATA controller supported by the Intel PCH chip. The options are **Enabled** and Disabled.

****If the feature "SATA Controller(s)" above is set to Enabled, the following settings will become available for configuration:***

SATA Mode Selection

Use this feature to select the mode for the installed SATA drives. The options are **AHCI** and RAID.

SATA Frozen

Use this feature to enable the HDD Security Frozen Mode. The options are Enabled and **Disabled**.

Aggressive LPM Support

When Aggressive Link Power Management (LPM) support is set to Enabled, the SATA AHCI controller manages the power usage of the SATA link. The controller will put the link in a low power mode during extended periods of I/O inactivity, and will return the link to an active state when I/O activity resumes. The options are **Disabled** and Enabled.

Storage Option ROM/UEFI Driver

Select UEFI to load the EFI driver for system boot. Select Legacy to load a legacy driver for system boot. The options are Do Not Launch, UEFI, and **Legacy**.

Serial ATA Port 0 ~ Port 5

This feature displays the information detected on the installed SATA drive on the particular SATA port.

- Model number of drive and capacity
- Software Preserve Support

Port 0 ~ Port 5 Hot Plug

Set this feature to Enabled for hot plug support, which will allow the user to replace a SATA drive without shutting down the system. The options are Disabled and **Enabled**.

Port 0 ~ Port 5 Spin Up Device

On an edge detect from 0 to 1, set this feature to allow the PCH to initialize the device. The options are **Disabled** and Enabled.

Port 0 ~ Port 5 SATA Device Type

Use this feature to specify if the SATA port specified by the user should be connected to a Solid State drive or a Hard Disk Drive. The options are **Hard Disk Drive** and Solid State Drive.

► PCH-FW Configuration

The following firmware information will display:

- Operational Firmware Version
- Backup Firmware Version
- Recovery Firmware Version
- ME Firmware Features
- ME Firmware Status #1
- ME Firmware Status #2
- Current State
- Error Code

► ACPI Settings

WHEA Support

Select Enabled to support the Windows Hardware Error Architecture (WHEA) platform and provide a common infrastructure for the system to handle hardware errors within the Windows OS environment to reduce system crashes and to enhance system recovery and health monitoring. The options are Disabled and **Enabled**.

High Precision Event Timer

Select Enabled to activate the High Precision Event Timer (HPET) that produces periodic interrupts at a much higher frequency than a Real-time Clock (RTC) does in synchronizing multimedia streams, providing smooth playback and reducing the dependency on other timestamp calculation devices, such as an x86 RDTSC Instruction embedded in the CPU. The High Performance Event Timer is used to replace the 8254 Programmable Interval Timer. The options are Disabled and **Enabled**.

Native PCIE Enable

Enable this feature to grant native control of hot plug, Power Management Events, PCI-E Advanced Error Reporting, PCI-E Capability Structure Control, and Latency Tolerance Reporting Control. The options are Disabled and **Enabled**.

Native ASPM

Select Enabled for the operating system to control the Active State Power Management (ASPM). Select Disabled for the BIOS to control the ASPM. The options are **Auto**, Enabled, and Disabled.

►USB Configuration

The following USB items will be displayed:

- USB Module Version
- USB Controllers
- USB Devices

Legacy USB Support (Available when USB Functions are not Disabled)

Select Enabled to support legacy USB devices. Select Auto to disable legacy support if USB devices are not present. Select Disabled to have USB devices available for Extensive Firmware Interface (EFI) applications only. The settings are **Enabled**, Disabled, and Auto.

XHCI Hand-off

This feature is for operating systems that do not support eXtensible Host Controller Interface (XHCI) hand-off. When this feature is enabled, XHCI ownership change will be claimed by the XHCI driver. The settings are **Enabled** and Disabled.

USB Mass Storage Driver Support

Select Enabled for USB mass storage device support. The options are Disabled and **Enabled**.

Port 60/64 Emulation

Select Enabled for I/O port 60h/64h emulation support which will provide complete USB keyboard legacy support for the operating system that does not support Legacy USB devices. The options are Disabled and **Enabled**.

►PCIe/PCI/PnP Configuration

Option ROM Execution

Video

This feature controls which option ROM to execute for the video device. The options are Do Not Launch, UEFI, and **Legacy**.

PCI PERR/SERR Support

Select Enabled to allow a PCI device to generate a PERR/SERR number for a PCI Bus Signal Error Event. The options are **Disabled** and Enabled.

Above 4GB MMIO BIOS Assignment

Select Enabled to decode a PCI device that supports 64-bit in the space above 4G Address. The options are Enabled and **Disabled**.

VGA Priority

Use this feature to select VGA priority when multiple VGA devices are detected. Select Onboard to give priority to your onboard video device. Select Offboard to give priority to your graphics card. The options are **Onboard** and Offboard.

Onboard Video Option ROM

Use this feature to select the onboard video firmware type to be loaded. The options are **Legacy** and EFI.

NVMe Firmware Source

Use this feature to select the NVMe firmware to support booting. The options are **Vendor Defined Firmware** and AMI Native Support. The default option, Vendor Defined Firmware, is pre-installed on the drive and may resolve errata or enable innovative functions for the drive. The other option, AMI Native Support, is offered by the BIOS with a generic method.

PCIe/PCI/PnP Configuration

CPU SLOT4 PCI-E 3.0 X4 (IN X8) OPROM

Use this feature to select which firmware type to be loaded for the add-on card in this slot. The options are Disabled, **Legacy**, and EFI.

CPU SLOT5 PCI-E 3.0 X4 (IN X8) OPROM

Use this feature to select which firmware type to be loaded for the add-on card in this slot. The options are Disabled, **Legacy**, and EFI.

CPU SLOT6 PCI-E 3.0 X8 (IN X16) OPROM

Use this feature to select which firmware type to be loaded for the add-on card in this slot. The options are Disabled, **Legacy**, and EFI.

M.2 PCI-E 3.0 X4 OPROM

Use this feature to select which firmware type to be loaded for the add-on card in this slot. The options are Disabled, **Legacy**, and EFI.

Onboard LAN1 Support

Use this feature to enable support for Onboard LAN1. The options are **Enabled** and Disabled.

Onboard LAN2 Support

Use this feature to enable support for Onboard LAN2. The options are **Enabled** and Disabled.

Onboard LAN Option ROM Type

Use this feature to select which firmware type to be loaded for onboard LAN ports. The options are **Legacy** and EFI.

****If the feature above is set to Legacy, the following LAN ports will be listed and become available for configuration:***

Onboard LAN1 ~ LAN2 Option ROM

Use this feature to select which firmware function to be loaded for the specified onboard LAN port at system boot. The options are **Disabled**, PXE, and iSCSI*.

****iSCSI is only supported on Onboard LAN1. The default setting for Onboard LAN1 is PXE.***

Network Stack

Select Enabled to enable Preboot Execution Environment (PXE) or Unified Extensible Firmware Interface (UEFI) for network stack support. The options are Disabled and **Enabled**.

****If the feature above is set to Enabled, the following settings will become available for configuration:***

Ipv4 PXE Support

Select Enabled to enable IPv4 PXE boot support. The options are Disabled and **Enabled**.

Ipv4 HTTP Support

Select Enabled to enable IPv4 HTTP boot support. The options are **Disabled** and Enabled.

Ipv6 PXE Support

Select Enabled to enable IPv6 PXE boot support. The options are Disabled and **Enabled**.

Ipv6 HTTP Support

Select Enabled to enable IPv6 HTTP boot support. The options are **Disabled** and Enabled.

IPSEC Certificate

Internet Protocol Security (IPSEC) offers a secure connection for remote computers using a secure tunnel. The options are **Disabled** and Enabled.

PXE Boot Wait Time

Use this feature to specify the wait time to press the ESC key to abort the PXE boot. Press "+" or "-" on your keyboard to change the value. The default setting is **0**.

Media Detect Count

Use this feature to specify the number of times media will be checked. Press "+" or "-" on your keyboard to change the value. The default setting is **1**.

► Trusted Computing

The X11SCL-F supports TPM 1.2 and 2.0. The following Trusted Platform Module (TPM) information will display if a TPM 2.0 module is detected:

- Firmware Version
- Vendor Name

Security Device Support

If this feature and the TPM jumper on the motherboard are both set to Enable, onboard security devices will be enabled for TPM (Trusted Platform Module) support to enhance data integrity and network security. Please reboot the system for a change on this setting to take effect. The options are Disable and **Enable**.

- Active PCR Bank
- SHA256 PCR Bank

****If a TPM is installed and the feature above is set to Enable, "SHA-1 PCR Bank", "SHA256 PCR Bank", and additional settings will become available for configuration:***

SHA-1 PCR Bank

Use this feature to disable or enable the SHA-1 Platform Configuration Register (PCR) bank for the installed TPM device. The options are Disabled and **Enabled**.

SHA256 PCR Bank

Use this feature to disable or enable the SHA256 Platform Configuration Register (PCR) bank for the installed TPM device. The options are Disabled and **Enabled**.

Pending Operation

Use this feature to schedule a TPM-related operation to be performed by a security device for system data integrity. Your system will reboot to carry out a pending TPM operation. The options are **None** and TPM Clear.

Platform Hierarchy

Use this feature to disable or enable platform hierarchy for platform protection. The options are Disabled and **Enabled**.

Storage Hierarchy

Use this feature to disable or enable storage hierarchy for cryptographic protection. The options are Disabled and **Enabled**.

Endorsement Hierarchy

Use this feature to disable or enable endorsement hierarchy for privacy control. The options are Disabled and **Enabled**.

TPM2.0 UEFI Spec Version

Use this feature to specify the TPM UEFI spec version. TCG 1.2 supports Windows® 2012, Windows 8, and Windows 10. TCG 2 supports Windows 10 or later. The options are TCG_1_2 and **TCG_2**.

Physical Presence Spec Version

Use this feature to select the PPI spec version. The options are 1.2 and **1.3**.

PH Randomization

Use this feature to disable or enable Platform Hierarchy (PH) Randomization. The options are Disabled and **Enabled**.

Device Select

Use this feature to select the TPM version. TPM 1.2 will restrict support to TPM 1.2 devices. TPM 2.0 will restrict support for TPM 2.0 devices. Select Auto to enable support for both versions. The options are TPM 1.2, TPM 2.0, and **Auto**.

SMCI BIOS-Based TPM Provision Support

Use this feature to enable the Supermicro TPM Provision support. The options are Disabled and **Enabled**.

TXT Support

Intel Trusted Execution Technology (TXT) helps protect against software-based attacks and ensures protection, confidentiality, and integrity of data stored or created on the system. Use this feature to enable or disable TXT Support. The options are **Disabled** and Enabled.

► HTTP Boot Configuration

Http Boot One Time

After creating and saving a HTTP boot option, enable this feature to have the system auto boot into the newly created HTTP boot option the next time the system is powered on. The options are **Disabled** and Enabled.

Input The Description

Use this feature to input the HTTP boot option description.

Boot URi

Use this feature to input the URi address for HTTP Boot feature.

► iSCSI Configuration

This submenu is available for configuration when "Network Stack" is enabled under the submenu, "PCIe/PCI/PnP Configuration".

iSCSI Initiator Name

This feature allows the user to enter the unique name of the iSCSI Initiator in IQN format. Once the name of the iSCSI Initiator is entered into the system, configure the proper settings for the following features.

► Add an Attempt

► Delete Attempts

► Change Attempt Order

► TLS Authentication Configuration

This submenu allows the user to configure Transport Layer Security (TLS) settings.

► Server CA Configuration

► Enroll Certification

Enroll Certification Using File

Use this feature to enroll certification from a file.

Certification GUID

Use this feature to input the certification GUID.

Commit Changes and Exit

Use this option to save all changes and exit TLS settings.

Discard Changes and Exit

Use this option to discard all changes and exit TLS settings.

► Delete Certification

Use this feature to delete certification.

4.4 Event Logs

Use this feature to configure Event Log settings.

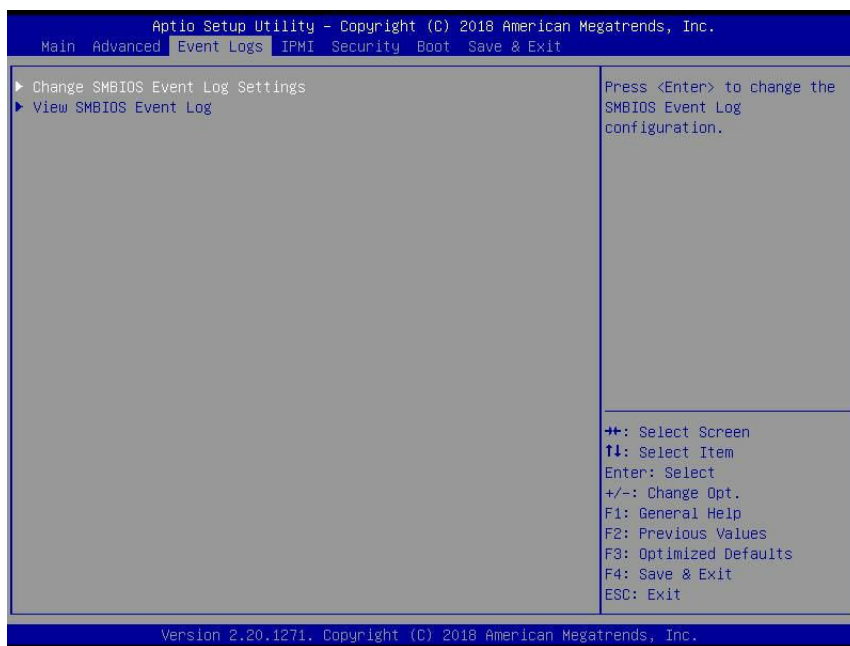

► Change SMBIOS Event Log Settings

Enabling/Disabling Options

SMBIOS Event Log

Change this feature to enable or disable all features of the SMBIOS Event Logging during system boot. The options are Disabled and **Enabled**.

Erasing Settings

Erase Event Log

If No is selected, data stored in the event log will not be erased. Select Yes, Next reset, data in the event log will be erased upon next system reboot. Select Yes, Every reset, data in the event log will be erased upon every system reboot. The options are **No**, Yes, Next reset, and Yes, Every reset.

When Log is Full

Select Erase Immediately for all messages to be automatically erased from the event log when the event log memory is full. The options are **Do Nothing** and Erase Immediately.

SMBIOS Event Log Standard Settings

Log System Boot Event

This feature toggles the System Boot Event logging to enabled or disabled. The options are Enabled and **Disabled**.

MECI

The Multiple Event Count Increment (MECI) counter counts the number of occurrences that a duplicate event must happen before the MECI counter is incremented. This is a numeric value. The default value is **1**.

METW

The Multiple Event Time Window (METW) defines the number of minutes that must pass between duplicate log events before MECI is incremented. This is in minutes, from 0 to 99. The default value is **60**.



Note: After making changes on a setting, be sure to reboot the system for the changes to take effect.

►View SMBIOS Event Log

Select this submenu and press enter to see the contents of the SMBIOS event log. The following categories will be displayed: Date/Time/Error Codes/Severity.

4.5 IPMI

Use this feature to configure Intelligent Platform Management Interface (IPMI) settings.



BMC Firmware Revision

This item indicates the IPMI firmware revision used in your system.

IPMI Status (Baseboard Management Controller)

This item indicates the status of the IPMI firmware installed in your system.

▶ System Event Log

Enabling/Disabling Options

SEL Components

Select Enabled for all system event logging at bootup. The options are Disabled and Enabled.

Erasing Settings

Erase SEL

Select Yes, On next reset to erase all system event logs upon next system reboot. Select Yes, On every reset to erase all system event logs upon each system reboot. Select No to keep all system event logs after each system reboot. The options are **No**, Yes, On next reset, and Yes, On every reset.

When SEL is Full

This feature allows the user to decide what the BIOS should do when the system event log is full. Select Erase Immediately to erase all events in the log when the system event log is full. The options are **Do Nothing** and Erase Immediately.



Note: After making changes on a setting, be sure to reboot the system for the changes to take effect.

► BMC Network Configuration

BMC Network Configuration

Update IPMI LAN Configuration

Select Yes for the BIOS to implement all IP/MAC address changes at the next system boot. The options are **No** and Yes.

****If the feature above is set to Yes, the following settings will become available for configuration:***

Configure IPV4 Support

This section displays configuration features for IPV4 support.

IPMI LAN Selection

This feature displays the IPMI LAN setting. The default setting is **Failover**.

IPMI Network Link Status

This feature displays the IPMI Network Link status. The default setting is **Shared LAN**.

Configuration Address Source

This feature allows the user to select the source of the IP address for this computer. If Static is selected, you will need to know the IP address of this computer and enter it to the system manually in the field. If DHCP is selected, the BIOS will search for a DHCP (Dynamic Host Configuration Protocol) server attached to the network and request the next available IP address for this computer. The options are Static and **DHCP**.

****If the feature above is set to Static, the following settings will become available for configuration:***

Station IP Address

This feature displays the Station IP address for this computer. This should be in decimal and in dotted quad form (i.e., 192.168.10.253).

Subnet Mask

This feature displays the subnetwork that this computer belongs to. The value of each three-digit number separated by dots should not exceed 255.

Station MAC Address

This feature displays the Station MAC address for this computer. Mac addresses are 6 two-digit hexadecimal numbers.

Gateway IP Address

This feature displays the Gateway IP address for this computer. This should be in decimal and in dotted quad form (i.e., 172.31.0.1).

VLAN

This feature displays the virtual LAN settings. The options are **Disable** and **Enable**.

****If the feature above is set to Enable, "VLAN ID" will become available available for configuration:***

VLAN ID

Use this feature to enter the VLAN ID. The default setting is **0**.

Configure IPV6 Support

This section displays configuration features for IPV6 support.

IPV6 Address Status

This feature displays the IPV6 Address status. The default setting is **Disabled**.

IPV6 Support

Use this feature to enable IPV6 support. The options are **Enabled** and **Disabled**.

****If the feature above is set to Enabled, the following settings will become available for configuration:***

Configuration Address Source

This feature allows the user to select the source of the IP address for this computer. If Static is selected, you will need to know the IP address of this computer and enter it to the system manually in the field. If DHCP is selected, the BIOS will search for a DHCP (Dynamic Host Configuration Protocol) server attached to the network and request the next available IP address for this computer. The options are Static and **DHCP**.

****If the feature above is set to Static, the following settings will become available for configuration:***

- Station IPV6 Address
- Prefix Length
- IPV6 Router1 IP Address

4.6 Security

This menu allows the user to configure the following security settings for the system.

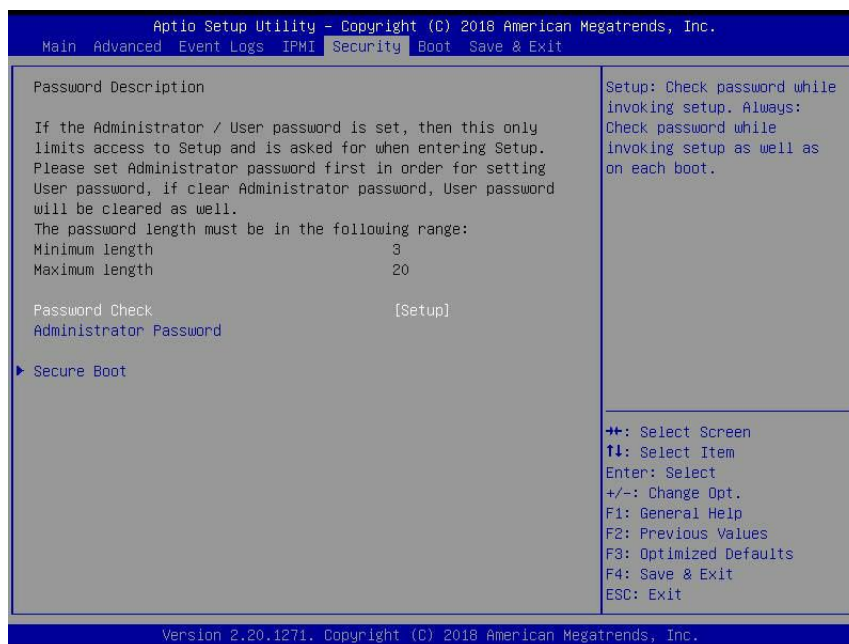

Password Check

Select Setup for the system to check for a password at Setup. Select Always for the system to check for a password at bootup or upon entering the BIOS Setup utility. The options are **Setup** and **Always**.

Administrator Password

Press Enter to create a new, or change an existing, Administrator password.

► Secure Boot

This section displays the contents of the following secure boot features:

- System Mode
- Vendor Keys
- Secure Boot

Secure Boot

Use this feature to enable secure boot. The options are **Disabled** and **Enabled**.

Secure Boot Mode

Use this feature to configure Secure Boot variables without authentication. The options are **Standard** and **Custom**.

CSM Support

Select Enabled to support the EFI Compatibility Support Module (CSM), which provides compatibility support for traditional legacy BIOS for system boot. The options are Disabled and **Enabled**.

▶ Key Management

This submenu allows the user to configure the following Key Management settings.

▶ Restore Factory Keys

Select Yes to restore all factory keys to the default settings. The options are **Yes** and No.

▶ Reset to Setup Mode

Select Yes to delete all Secure Boot key databases and force the system to Setup Mode. The options are **Yes** and No.

▶ Export Secure Boot variables

Use this feature to copy the NVRAM contents of the secure boot variables to a file.

▶ Enroll EFI Image

This feature allows the image to run in Secure Boot Mode. Enroll SHA256 Hash Certificate of the image into the Authorized Signature Database.

Device Guard Ready

▶ Remove 'UEFI CA' from DB

Use this feature to remove the Microsoft UEFI CA certificate from the database. The options are **Yes** and No.

▶ Restore DB Defaults

Select Yes to restore the DB defaults. The options are **Yes** and No.

Secure Boot Variable

▶ Platform Key (PK)

This feature allows the user to update the settings of the platform keys.

Update

Select Yes to load a factory default PK or No to load from a file on an external media. The options are **Yes** and No.

▶ **Key Exchange Keys**

Update

Select Yes to load the KEK from the manufacturer's defaults. Select No to load the KEK from a file. The options are **Yes** and No.

Append

Select Yes to add the KEK from the manufacturer's defaults list to the existing KEK. Select No to load the KEK from a file. The options are **Yes** and No.

▶ **Authorized Signatures**

Update

Select Yes to load the database from the manufacturer's defaults. Select No to load the DB from a file. The options are **Yes** and No.

Append

Select Yes to add the database from the manufacturer's defaults to the existing DB. Select No to load the DB from a file. The options are **Yes** and No.

▶ **Forbidden Signatures**

Update

Select Yes to load the DBX from the manufacturer's defaults. Select No to load the DBX from a file. The options are **Yes** and No.

Append

Select Yes to add the DBX from the manufacturer's defaults to the existing DBX. Select No to load the DBX from a file. The options are **Yes** and No.

▶ **Authorized TimeStamps**

Update

Select Yes to load the DBT from the manufacturer's defaults. Select No to load the DBT from a file. The options are **Yes** and No.

Append

Select Yes to add the DBT from the manufacturer's defaults list to the existing DBT. Select No to load the DBT from a file. The options are **Yes** and No.

► OsRecovery Signature

This feature uploads and installs an OSRecovery Signature. You may insert a factory default key or load from a file. The file formats accepted are:

- 1) Public Key Certificate
 - a. EFI Signature List
 - b. EFI CERT X509 (DER Encoded)
 - c. EFI CERT RSA2048 (bin)
 - d. EFI SERT SHA256 (bin)
- 2) EFI Time Based Authenticated Variable

When prompted, select "Yes" to load Factory Defaults or "No" to load from a file.

Update

Select Yes to load the DBR from the manufacturer's defaults. Select No to load the DBR from a file. The options are **Yes** and No.

Append

This feature uploads and adds an OSRecovery Signature into the Key Management. You may insert a factory default key or load from a file. When prompted, select "**Yes**" to load Factory Defaults or "No" to load from a file.

4.7 Boot

Use this feature to configure Boot settings.

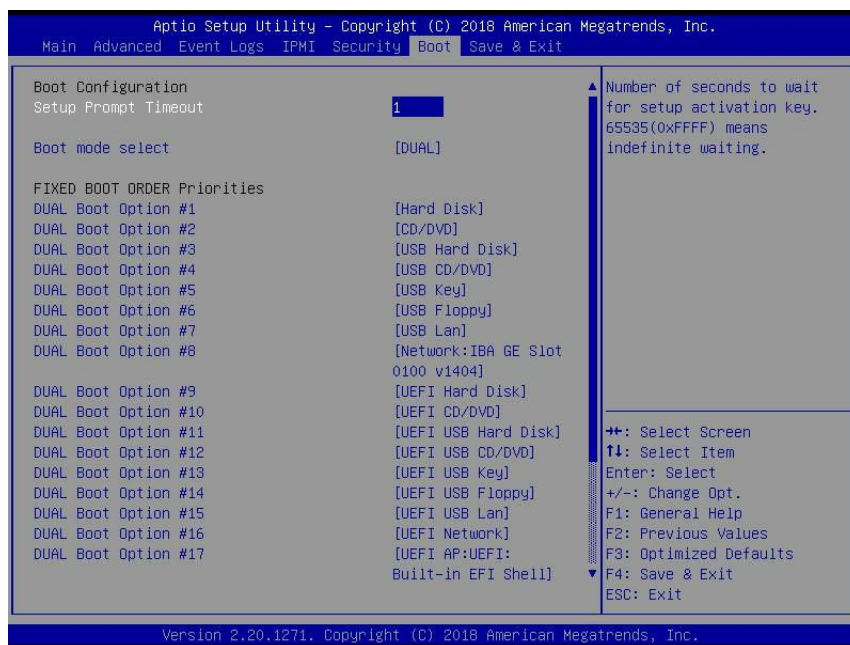

Setup Prompt Timeout

Use this feature to indicate the length of time (the number of seconds) for the BIOS to wait before rebooting the system when the setup activation key is pressed. Enter the value of 65535 (0xFFFF) for the BIOS to wait indefinitely. The default setting is **1**.

Boot Mode Select

Use this feature to select the type of device that the system is going to boot from. The options are Legacy, UEFI, and **Dual**.

Fixed Boot Order Priorities

This feature prioritizes the order of bootable devices that the system boots from. Press <Enter> on each entry from top to bottom to select devices.

****If the feature "Boot Mode Select" above is set to Legacy, UEFI, or Dual, the following settings will be available for configuration:***

- Legacy/UEFI/Dual Boot Option #1
- Legacy/UEFI/Dual Boot Option #2
- Legacy/UEFI/Dual Boot Option #3
- Legacy/UEFI/Dual Boot Option #4

- Legacy/UEFI/Dual Boot Option #5
- Legacy/UEFI/Dual Boot Option #6
- Legacy/UEFI/Dual Boot Option #7
- Legacy/UEFI/Dual Boot Option #8
- UEFI/Dual Boot Option #9
- Dual Boot Option #10
- Dual Boot Option #11
- Dual Boot Option #12
- Dual Boot Option #13
- Dual Boot Option #14
- Dual Boot Option #15
- Dual Boot Option #16
- Dual Boot Option #17

► Delete Boot Option

This feature allows the user to select an EFI boot option to delete from the boot order.

Delete Boot Option

Use this feature to remove an EFI boot option from the boot priority list.

► Delete Driver Option

This feature allows the user to select an EFI driver option to delete from the drive order.

****If any storage media is detected, "Add New Boot Option" and "Add New Driver Option" will become available for configuration:***

► Add New Boot Option

This feature allows the user to add a new EFI boot option to the boot order for your system.

Add Boot Option

Use this feature to specify the name for the new boot option.

Path for Boot Option

Use this feature to enter the path for the new boot option in the format fsx:\path\filename.efi.

Boot Option File Path

Use this feature to specify the file path for the new boot option.

Create

Use this feature to set the name and the file path of the new boot option.

► Add New Driver Option

This feature allows the user to add a new EFI driver option to the driver order for your system.

Add Driver Option

Use this feature to specify the name for the new driver option.

Path for Boot Option

Use this feature to enter the path for the new driver option in the format fsx:\path\filename.efi.

Driver Option File Path

Use this feature to specify the file path for the new driver option.

Create

Use this feature to set the name and the file path of the new driver option.

► UEFI Application Boot Priorities

This feature allows the user to specify which UEFI devices are boot devices.

- UEFI Boot Option #1

► NETWORK Drive BBS Priorities

This feature sets the system boot order of detected devices.

- Boot Option #1

****If any storage media is detected, the following features will become available for configuration:***

▶ UEFI Hard Disk Drive BBS Priorities

This feature sets the system boot order of detected devices.

- Boot Option #1

▶ Hard Disk Drive BBS Priorities

This feature sets the system boot order of detected devices.

- Boot Option #1

4.8 Save & Exit

Select the Save & Exit tab from the BIOS setup screen to configure the settings below:

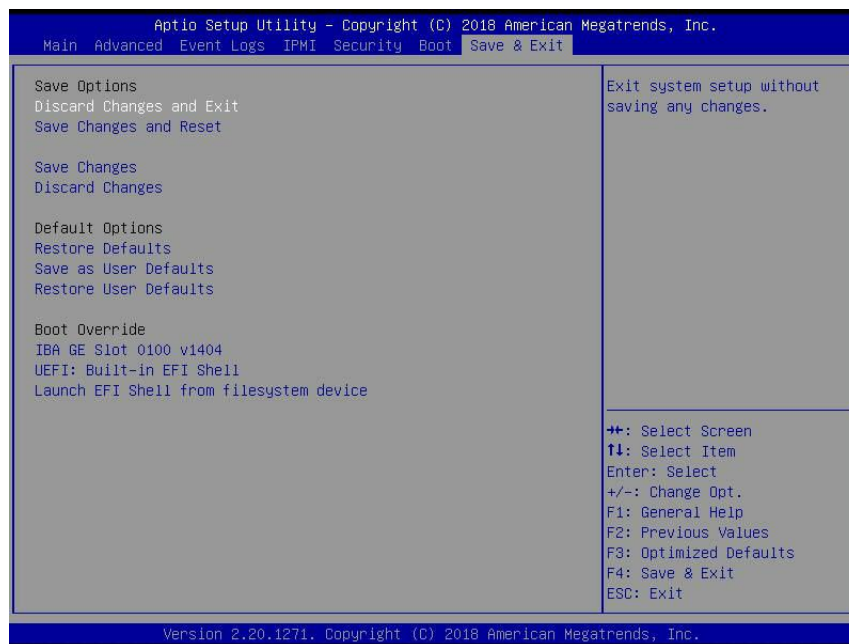

Save Options

Discard Changes and Exit

Select this feature to quit the BIOS Setup without making any permanent changes to the system configuration and reboot the computer. Select Discard Changes and Exit from the Save & Exit menu and press <Enter>.

Save Changes and Reset

After completing the system configuration changes, select this feature to save the changes you have made. This will not reset (reboot) the system.

Save Changes

When you have completed the system configuration changes, select this feature to leave the BIOS setup utility and reboot the computer for the new system configuration parameters to take effect. Select Save Changes from the Save & Exit menu and press <Enter>.

Discard Changes

Select this feature and press <Enter> to discard all the changes and return to the AMI BIOS utility program.

Default Options**Restore Defaults**

To set this feature, select Restore Defaults from the Save & Exit menu and press <Enter>. These are factory settings designed for maximum system stability, but not for maximum performance.

Save As User Defaults

To set this feature, select Save as User Defaults from the Save & Exit menu and press <Enter>. This enables the user to save any changes to the BIOS setup for future use.

Restore User Defaults

To set this feature, select Restore User Defaults from the Save & Exit menu and press <Enter>. Use this feature to retrieve user-defined settings that were saved previously.

Boot Override

Listed in this section are other boot options for the system (i.e., Built-in EFI shell). Select an option and press <Enter>. Your system will boot to the selected boot option.

Appendix A

BIOS Codes

A.1 BIOS Error POST (Beep) Codes

During the POST (Power-On Self-Test) routines, which are performed each time the system is powered on, errors may occur.

Non-fatal errors are those which, in most cases, allow the system to continue the boot-up process. The error messages normally appear on the screen.

Fatal errors are those which will not allow the system to continue the boot-up procedure. If a fatal error occurs, you should consult with your system manufacturer for possible repairs.

These fatal errors are usually communicated through a series of audible beeps. The table shown below lists some common errors and their corresponding beep codes encountered by users.

BIOS Beep (POST) Codes		
Beep Code	Error Message	Description
1 beep	Refresh	Circuits have been reset (Ready to power up)
5 short, 1 long	Memory error	No memory detected in system
5 long, 2 short	Display memory read/write error	Video adapter missing or with faulty memory
1 long continuous	System OH	System overheat condition

A.2 Additional BIOS POST Codes

The AMI BIOS supplies additional checkpoint codes, which are documented online at <http://www.supermicro.com/support/manuals/> ("AMI BIOS POST Codes User's Guide").

When the BIOS performs the Power On Self Test, it writes checkpoint codes to I/O port 0080h. If the computer cannot complete the boot process, a diagnostic card can be attached to the computer to read I/O port 0080h (Supermicro p/n AOM-SPI80-V).

For information on AMI updates, please refer to <http://www.ami.com/products/>.

Appendix B

Software Installation

B.1 Installing Software Programs

The Supermicro website contains drivers and utilities for your system at <https://www.supermicro.com/wftp/driver>. Some of these must be installed, such as the chipset driver.

After accessing the website, go into the CDR_Images (in the parent directory of the above link) and locate the ISO file for your motherboard. Download this file to create a DVD of the drivers and utilities it contains. (You may also use a utility to extract the ISO file if preferred.)

After creating a DVD with the ISO files, insert the disk into the DVD drive on your system and the display shown in Figure B-1 should appear.

Another option is to go to the Supermicro website at <http://www.supermicro.com/products/>. Find the product page for your motherboard here, where you may download individual drivers and utilities to your hard drive or a USB flash drive and install from there.

 **Note:** To install the Windows OS, please refer to the instructions posted on our website at <http://www.supermicro.com/support/manuals/>.

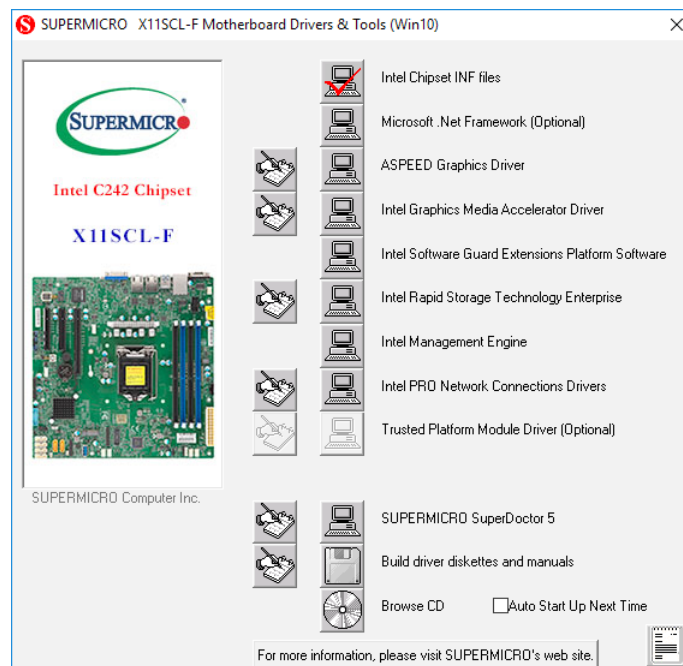

Figure B-1. Driver/Tool Installation Display Screen

Click the icons showing a hand writing on paper to view the readme files for each item. Click the computer icons to the right of these items to install each item (from top to bottom) one at a time. **After installing each item, you must reboot the system before moving on to the next item on the list.** The bottom icon with a CD on it allows you to view the entire contents.

B.2 SuperDoctor® 5

The Supermicro SuperDoctor 5 is a program that functions in a command-line or web-based interface for Windows and Linux operating systems. The program monitors such system health information as CPU temperature, system voltages, system power consumption, fan speed, and provides alerts via email or Simple Network Management Protocol (SNMP).

SuperDoctor 5 comes in local and remote management versions and can be used with Nagios to maximize your system monitoring needs. With SuperDoctor 5 Management Server (SSM Server), you can remotely control power on/off and reset chassis intrusion for multiple systems with SuperDoctor 5 or IPMI. SuperDoctor 5 Management Server monitors HTTP, FTP, and SMTP services to optimize the efficiency of your operation.



Note: The default User Name and Password for SuperDoctor 5 is admin / admin.

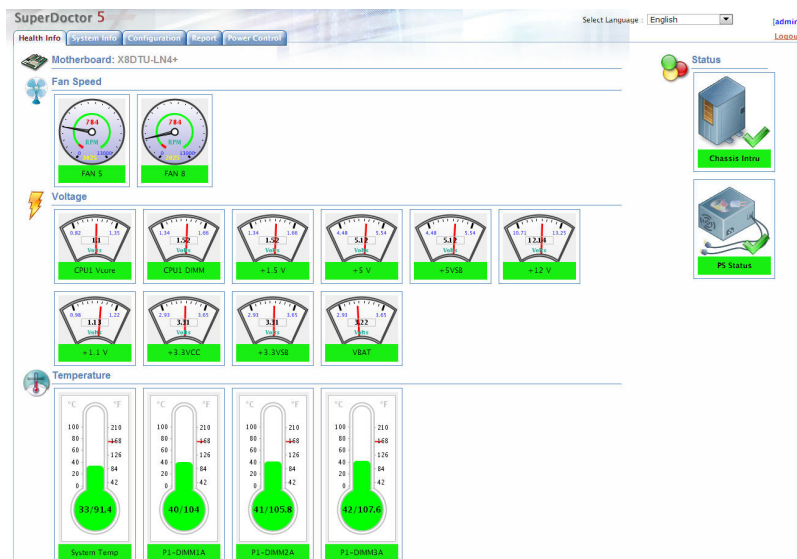

Figure B-2. SuperDoctor 5 Interface Display Screen (Health Information)



Note: The SuperDoctor 5 program and user's manual can be downloaded from the Supermicro website at http://www.supermicro.com/products/nfo/sms_sd5.cfm.

Appendix C

Standardized Warning Statements

The following statements are industry standard warnings, provided to warn the user of situations which have the potential for bodily injury. Should you have questions or experience difficulty, contact Supermicro's Technical Support department for assistance. Only certified technicians should attempt to install or configure components.

Read this section in its entirety before installing or configuring components.

These warnings may also be found on our website at http://www.supermicro.com/about/policies/safety_information.cfm.

Battery Handling



Warning! There is the danger of explosion if the battery is replaced incorrectly. Replace the battery only with the same or equivalent type recommended by the manufacturer. Dispose of used batteries according to the manufacturer's instructions

電池の取り扱い

電池交換が正しく行われなかった場合、破裂の危険性があります。交換する電池はメーカーが推奨する型、または同等のものを使用下さい。使用済電池は製造元の指示に従って処分して下さい。

警告

電池更換不當會有爆炸危險。請只使用同類電池或製造商推薦的功能相當的電池更換原有電池。請按製造商的說明處理廢舊電池。

警告

電池更換不當會有爆炸危險。請使用製造商建議之相同或功能相當的電池更換原有電池。請按照製造商的說明指示處理廢棄舊電池。

Warnung

Bei Einsetzen einer falschen Batterie besteht Explosionsgefahr. Ersetzen Sie die Batterie nur durch den gleichen oder vom Hersteller empfohlenen Batterietyp. Entsorgen Sie die benutzten Batterien nach den Anweisungen des Herstellers.

Attention

Danger d'explosion si la pile n'est pas remplacée correctement. Ne la remplacer que par une pile de type semblable ou équivalent, recommandée par le fabricant. Jeter les piles usagées conformément aux instructions du fabricant.

¡Advertencia!

Existe peligro de explosión si la batería se reemplaza de manera incorrecta. Reemplazar la batería exclusivamente con el mismo tipo o el equivalente recomendado por el fabricante. Desechar las baterías gastadas según las instrucciones del fabricante.

אזהרה!

קיימת סכנת פיצוץ של הסוללה במידה והוחלפה בדרך לא תקינה. יש להחליף את הסוללה בסוג התואם מחברת יצרן מומלצת. סילוק הסוללות המשומשות יש לבצע לפי הוראות היצרן.

هناك خطر من انفجار في حالة اسبدال البطارية بطريقة غير صحيحة فعلياً
اسبدال البطارية
فقط بنفس النوع أو ما يعادلها مما أوصت به الشركة المصنعة
جخلص من البطاريات المسحمة وفقاً لتعليمات الشركة الصانعة

경고!

배터리가 올바르게 교체되지 않으면 폭발의 위험이 있습니다. 기존 배터리와 동일하거나 제조사에서 권장하는 동등한 종류의 배터리로만 교체해야 합니다. 제조사의 안내에 따라 사용된 배터리를 처리하여 주십시오.

Waarschuwing

Er is ontploffingsgevaar indien de batterij verkeerd vervangen wordt. Vervang de batterij slechts met hetzelfde of een equivalent type die door de fabrikant aanbevolen wordt. Gebruikte batterijen dienen overeenkomstig fabrieksvoorschriften afgevoerd te worden.

Product Disposal



Warning! Ultimate disposal of this product should be handled according to all national laws and regulations.

製品の廃棄

この製品を廃棄処分する場合、国の関係する全ての法律・条例に従い処理する必要があります。

警告

本产品的废弃处理应根据所有国家的法律和规章进行。

警告

本產品的廢棄處理應根據所有國家的法律和規章進行。

Warnung

Die Entsorgung dieses Produkts sollte gemäß allen Bestimmungen und Gesetzen des Landes erfolgen.

¡Advertencia!

Al deshacerse por completo de este producto debe seguir todas las leyes y reglamentos nacionales.

Attention

La mise au rebut ou le recyclage de ce produit sont généralement soumis à des lois et/ou directives de respect de l'environnement. Renseignez-vous auprès de l'organisme compétent.

סילוק המוצר

אזהרה!

סילוק סופי של מוצר זה חייב להיות בהתאם להנחיות וחוקי המדינה.

التخلص النهائي من هذا المنتج ينبغي التعامل معه وفقا لجميع القوانين واللوائح الوطنية عند

경고!

이 제품은 해당 국가의 관련 법규 및 규정에 따라 폐기되어야 합니다.

Waarschuwing

De uiteindelijke verwijdering van dit product dient te geschieden in overeenstemming met alle nationale wetten en reglementen.

Appendix D

UEFI BIOS Recovery

Warning: Do not upgrade the BIOS unless your system has a BIOS-related issue. Flashing the wrong BIOS can cause irreparable damage to the system. In no event shall Supermicro be liable for direct, indirect, special, incidental, or consequential damages arising from a BIOS update. If you need to update the BIOS, do not shut down or reset the system while the BIOS is updating to avoid possible boot failure.

D.1 Overview

The Unified Extensible Firmware Interface (UEFI) provides a software-based interface between the operating system and the platform firmware in the pre-boot environment. The UEFI specification supports an architecture-independent mechanism that will allow the UEFI OS loader stored in an external storage device to boot the system. The UEFI offers clean, hands-off management to a computer during system boot.

D.2 Recovering the UEFI BIOS Image

A UEFI BIOS flash chip consists of a recovery BIOS block and a main BIOS block (a main BIOS image). The recovery block contains critical BIOS codes, including memory detection and recovery codes for the user to flash a healthy BIOS image if the original main BIOS image is corrupted. When the system power is turned on, the recovery block codes execute first. Once this process is complete, the main BIOS code will continue with system initialization and the remaining POST (Power-On Self-Test) routines.



Note 1: Follow the BIOS recovery instructions in Section D.3 for BIOS recovery when the main BIOS block crashes.

Note 2: If the recovery instructions in Section D.3 for BIOS recovery fail, you may use the Supermicro Update Manager (SUM) Out-of-Band (OOB) (https://www.supermicro.com.tw/products/nfo/SMS_SUM.cfm) to reflash the BIOS.

Note 3: If the recovery block processes stated in Note 1 and Note 2 above fail, you will need to follow the procedures to make a Returned Merchandise Authorization (RMA) request. Refer to Section 3.5 for more information about the RMA request.

D.3 Recovering the Main BIOS Block with a USB Device

This feature allows the user to recover the main BIOS image using a USB-attached device without additional utilities used. A USB flash device such as a USB Flash Drive, or a USB CD/DVD ROM/RW device can be used for this purpose. However, a USB hard disk drive cannot be used for BIOS recovery at this time. The file system supported by the recovery block is FAT (including FAT12, FAT16, and FAT32) which is installed on a bootable or non-bootable USB-attached device.

To perform UEFI BIOS recovery using a USB-attached device, follow the instructions below.

1. Please use a different machine to download the BIOS package for your motherboard or your system from the product page available on our website at www.supermicro.com.
2. Extract the BIOS package to a USB device and rename the BIOS ROM file [BIOSname#.###] that is included in the BIOS package to SUPER.ROM for BIOS recovery use.
3. Copy the SUPER.ROM file into the Root "\\" directory of the USB device.

 **Note:** Before recovering the main BIOS image, confirm that the SUPER.ROM file you have is the same version or a close version meant for your motherboard.

4. Insert the USB device that contains the SUPER.ROM file into the system before you power on the system or when the following screen appears.



5. After locating the SUPER.ROM file, the system will enter the BIOS Recovery menu as shown below.

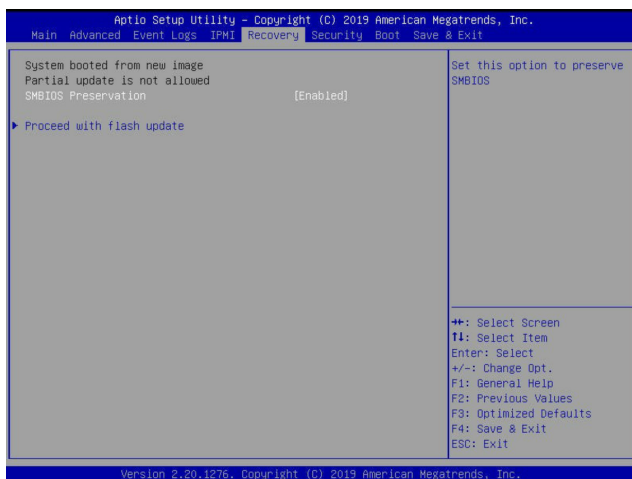

Note: At this point, you may decide if you want to start the BIOS recovery. If you decide to proceed with BIOS recovery, follow the procedures below.

6. When the screen as shown above displays, use the arrow keys to select the item "Proceed with flash update" and press the <Enter> key. You will see the BIOS recovery progress as shown in the screen below.

Note: Do not interrupt the BIOS flashing process until it is complete.

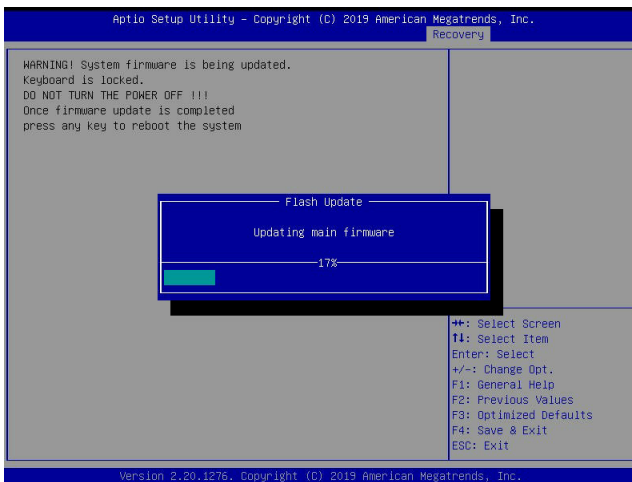

7. After the BIOS recovery process is complete, press any key to reboot the system.

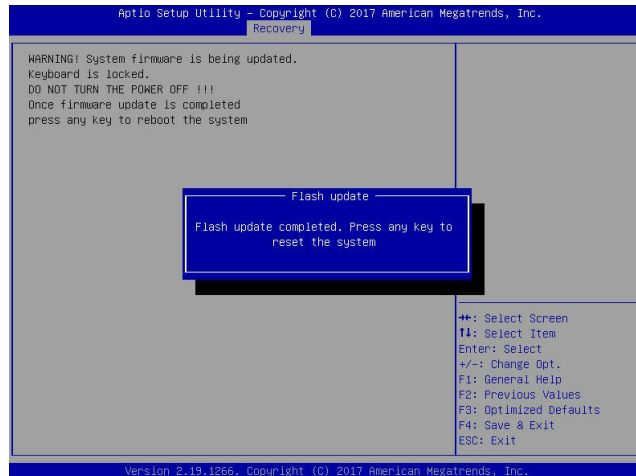

 **Note:** It is recommended that you update your BIOS after BIOS recovery. Please refer to Chapter 3 for BIOS update instructions.

8. Press during system boot to enter the BIOS Setup utility. From the top of the tool bar, select Boot to enter the submenu. From the submenu list, select Boot Option #1 as shown below. Then, set Boot Option #1 to [UEFI AP:UEFI: Built-in EFI Shell]. Press <F4> to save the settings and exit the BIOS Setup utility.

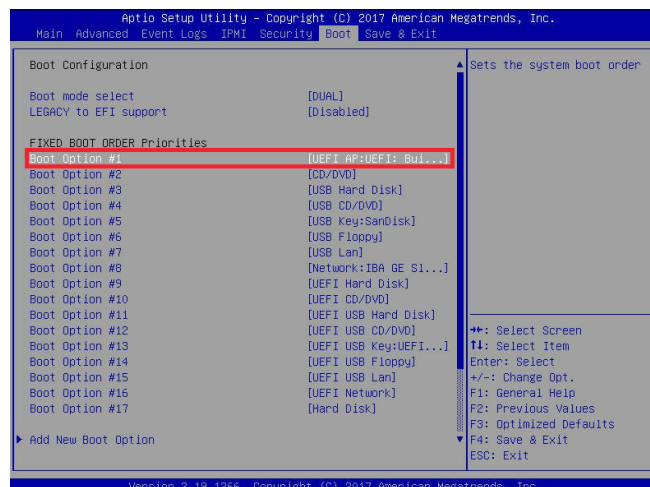

9. When the UEFI Shell prompt appears, type `fs#` to change the device directory path. Go to the directory that contains the BIOS package you extracted earlier in Step 2. Enter `flash.nsh BIOSname#.###` at the prompt to start the BIOS update process.

```

UEFI Interactive Shell v2.1
EDK II
UEFI v2.50 (American Megatrends, 0x0005000C)
Mapping Table
FS0: Alias(s):HD0:0B:BLK1:
      PciRoot(0x0)/Pci(0x14,0x0)/USB(0x11,0x0)/HD(1,MBR,0x3791D72,0x800,0x1
DR9592)
      BLK0: Alias(s):
      PciRoot(0x0)/Pci(0x14,0x0)/USB(0x11,0x0)
Press F8 in 1 seconds to skip startup.nsh or any other key to continue.
Shell> fs0:
FS0:\> cd \AFUDOS
FS0:\AFUDOS> cd \SNIPME2_03162017
FS0:\AFUDOS\SNIPME2_03162017> flash.nsh X110PU7_314

```



Note: Do not interrupt this process until the BIOS flashing is complete.

```

Done.
[ Access Cmos Port Ex ]
<Read>
Index 0x51: 0x10
Done.
*****
*
* Program BIOS and ME (including FDT) regions...
*
*****
| AMT Firmware Update Utility v5.09.01.1917 |
| Copyright (C)2017 American Megatrends Inc. All Rights Reserved. |
*****
CPUID = 50652
Reading flash ..... done
- ME Data Size checking - ok
- FFS checksums ..... ok
- Check RomLayout ..... Ok
Erasing Boot Block ..... done
Updating Boot Block ..... done
Verifying Boot Block ..... done
Erasing Main Block ..... 0x00132000 (0x)

```

10. The screen above indicates that the BIOS update process has completed. Reboot the system when you see the screen below.

```

Verifying NDB Block ..... done
- Update success for FDR
- Update success for IE
- Successful Update Recovery Loader to OPRx11
- Successful Update MFSB11
- Successful Update FPR11
- Successful Update MFS, IVB1 and IVB211
- Successful Update FLOG and UTDK11
- ME Entire Image update success !!
WARNING : System must power-off to have the changes take effect !!
Moving FS0:\AFUDOS\SNIPME2_03162017\fdt\k64.efi -> FS0:\AFUDOS\SNIPME2_03162017\
d1.smc
- [ok]
Moving FS0:\AFUDOS\SNIPME2_03162017\afuef1k64.efi -> FS0:\AFUDOS\SNIPME2_0316201
7\afuef1.smc
- [ok]
*****
* Please ignore this 'Shell: Cannot read from file - Device Error'
* warning message due to it does not impact flashing process.
*
*****
Deleting "afuef1.smc"
Delete successful.
FS0:\>

```